

STAINLESS STEEL SUBMERSIBLE PUMPS

FOR CHEMICALLY AGGRESSIVE LIQUIDS



Ranges CH, CTP, CMXS, CV, CVX, CK | Discharge 2" - DN 150





HIGHER PERFORMANCE TO MEET EVERY CHALLENGE

HIGH EFFICIENCY AND ECONOMY

HOMA submersible waste water and sewage pumps operate worldwide in numerous kinds of domestic, municipal and industrial applications. Decades of experience in the design and manufacturing of submersible pumps plus uncompromising attention to quality in every detail and strict monitoring of production quality ensure the utmost reliability and long service life of all HOMA products.

FLEXIBLE SYSTEM-COMPONENTS FOR PROBLEM-FREE INSTALLATION

HOMA combines efficiency, safety, high quality and robust design with a flexibility that allows the individual optimization of every project realization: Pumps for various types of application and installation, a complete program of installation equipment including pipes, valves, pump pits from concrete or composite materials, electric control and monitoring systems. With this range HOMA can provide a tailor-made solution for every waste water pumping application.

THE RELIABILITY OF FULLY AUTOMATIC OPERATION

HOMA waste water pumping stations feature fully automatic control and monitoring. Reliable liquid level control systems of various types (float switch, pneumatic, ultrasound or electronic systems) are available to secure reliable pump operation at minimum energy consumption.

All possible fault factors like shaft seal condition, temperatures, moisture or power supply can be automatically monitored and transferred to various alarm systems.

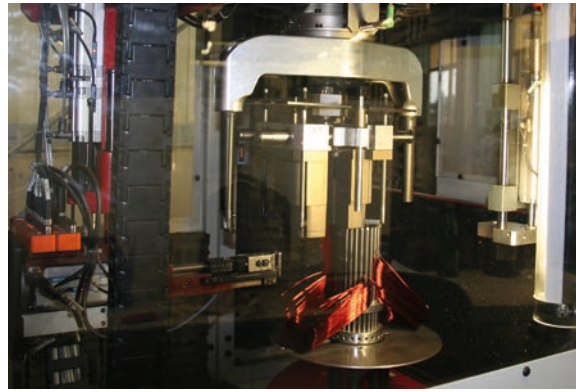

PROVEN TECHNOLOGY FOR EXTENDED APPLICATIONS

VARIOUS CHALLENGES - INDIVIDUAL SOLUTIONS

The stainless steel series based on the proven wastewater and sewage program made by HOMA. By using different high quality material options (different steel grades, bronze, Viton, etc.), the HOMA submersible pumps are used in various municipal and industrial applications:

- Oil and Gas
- Power Plants
- Industrial Applications
- Mining
- Chemical Processing
- Industrial Wastewater
- Shipbuilding / Offshore

MORE POWER FOR EVERY APPLICATION

Whether as a drainage pump in power plants, as leachate pumps in coal mining, as dewatering pumps for infrastructure projects, as sewage pumps for industrial wastewater or as ballast water pump in shipbuilding or naval sector, the „C“ series will find application with the proven features such as:

- Various impellers, depending on the pumped liquid
- Motors for continuous operation
- High-quality materials
- Robust and reliable construction



FOR MORE SAFETY AND LONGEVITY

MORE ADVANTAGES IN ALL OPERATING MODES

The motors are designed for continuous operating duty (S1) at maximum 15 starts per hour.

Pumps with enclosed single-channel impellers are designed for intermittent operation, normally in automatic level-controlled wet or dry well sump installations. They are also suitable for limited continuous operation. Vortex or enclosed multichannel impeller pumps are also designed for unlimited continuous operation, such as industrial water supply.

HIGH QUALITY IN DESIGN AND MATERIALS – LESS MAINTENANCE AND FAILURES

Quality can be measured – HOMA submersible waste water pumps are characterized by the robust design, generous dimensioning and high quality materials of all components.



THE RIGHT INSTALLATION FOR EVERY PUMP STATION

PERMANENT WET WELL INSTALLATION

Submerged autocoupling guide tube system for automatic connection and disconnection of the pump from the pipework from outside the sump. All maintenance or repair work can be done outside the sump. Back in operating position, the weight of the pump ensures leak-proof discharge connection.

TRANSPORTABLE WET WELL INSTALLATION

Submerged pump mounted on a ring base stand for temporary, service or emergency operation. Discharge connection with pipe or hose.

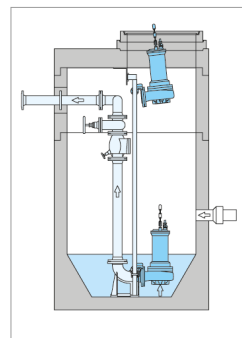

Permanent wet well installation

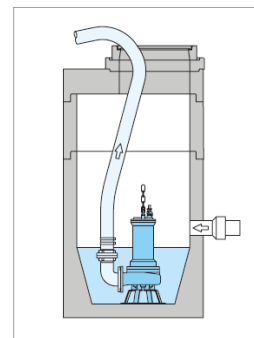

Transportable wet well installation

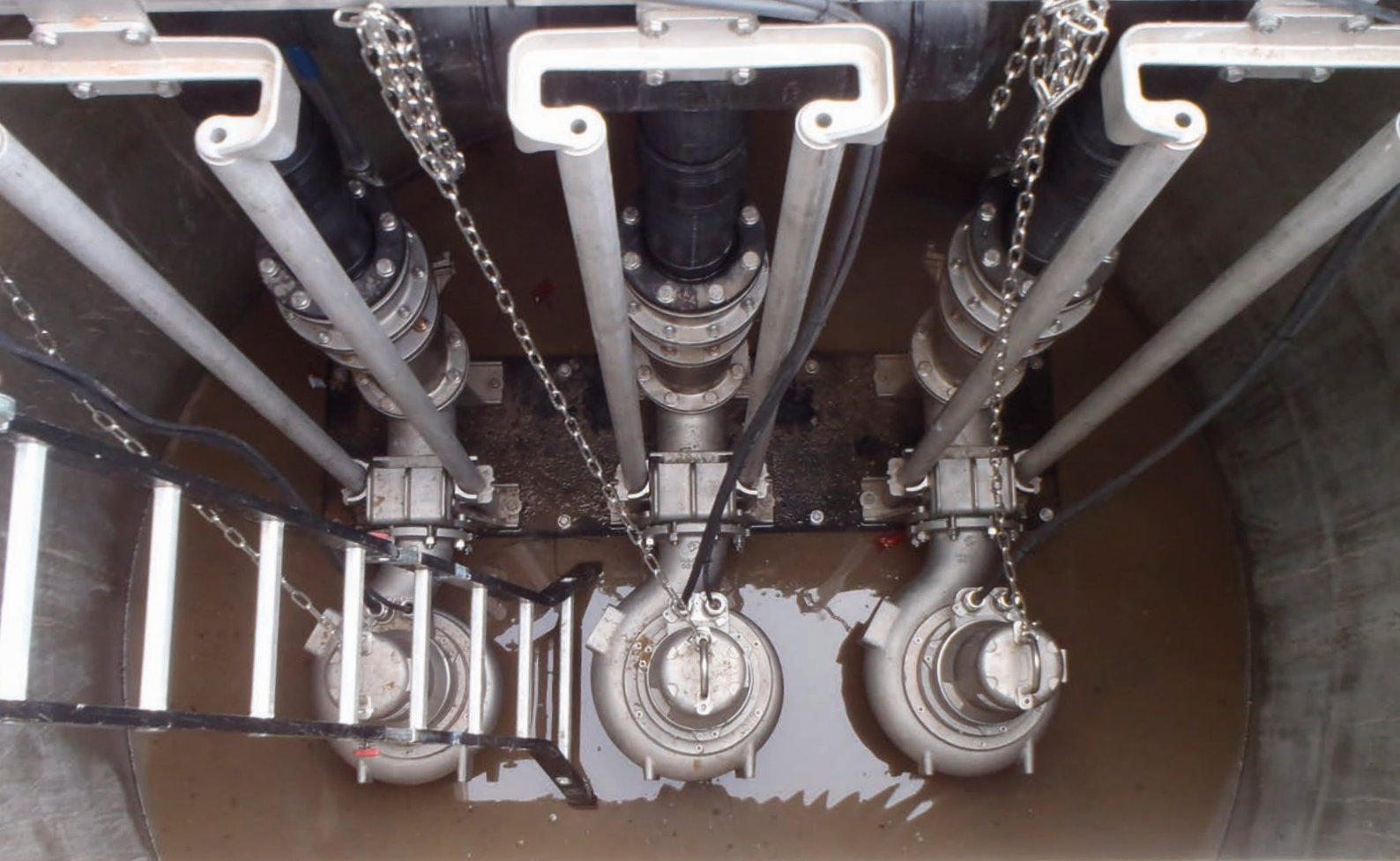

RANGES AND PUMP TYPES: CH - CTP

CH 432 - CH 436

HOMA CH 432 and CH 436 stainless steel submersible drainage pumps are suitable for pumping corrosive, abrasive or chemically aggressive liquids, drainage water or chemicals containing soft solids up to 10 mm diameter. They are used in various domestic, industrial or municipal applications.

CTP 50 / CTP 70

CTP stainless steel submersible drainage pumps are suitable for pumping corrosive, abrasive or chemically aggressive liquids, waste water or sewage and chemicals. Due to the large free passage of 50 or 70 mm diameter, they are particularly suitable for pumping liquids with solids and fiber content, for sewage disposal in industrial or municipal applications.



PUMP TYPE CODE: CH - CTP

Range	Model	Motor Power P1 (kW)	Speed	Voltages	Explosion Proof
Pump		Motor			
CH	432-436	-0,9	/2	W/D	(EX)
			2 = 2pole (2800 rpm)	W = 230V/1Ph 50Hz D = 400V/3Ph 50Hz	

Range	Spherical clearance / Discharge	Impeller	Motor Power P1 (kW)	Speed	Voltages	Explosion Proof
Pump			Motor			
CTP	50	M	13	/2	D (H)	(EX)
	50 = 50 mm 70 = 70 mm 50 = G2½ M 70 = DN 80	M = closed single channel impeller	13/10 = 1,3 kW	2 = 2pole (2800 rpm) 4 = 4pole (1450 rpm)	D = 400V/3Ph 50Hz HD = High pressure	

MOTOR SELECTION

Speed:

The motors are designed with the following speeds.

- 2800 rpm = 2-pole
- 1450 rpm = 4-pole

Voltage:

All specified data relate to an operating voltage of 230V/1Ph,50Hz or 400V/3Ph,50Hz. Different voltages are available on request.

Explosion protection:

In addition to the standard version, selected motors are also available explosion proof according to ATEX EX II 2 G Ex c d II B T4,(T3).

Motor monitoring:

All motors are supplied with temperature sensors in the winding, bi-metallic sensors (standard) or PTC-sensors (on request).

RANGES AND HYDRAULICS

HYDRAULIC SELECTION

Discharge:

- G 2 M
- G 2½ M
- DN 80

Reducing adapters for different autocoupling system and valve dimensions are available.

Impeller:

Different impeller designs are available to provide optimum performance and reliability with various liquids and operating conditions.

Impeller spherical clearance:

The pumps are available with impeller spherical clearances from 10 mm to 70 mm according to pump range.



CH Open Multichannel Impeller

For liquids containing smaller impurities like sand or sludge.



CTP Enclosed Single Channel Impeller

For liquids containing impurities and sludge with solid particles.

DESIGN - PROVEN QUALITY IN DETAIL

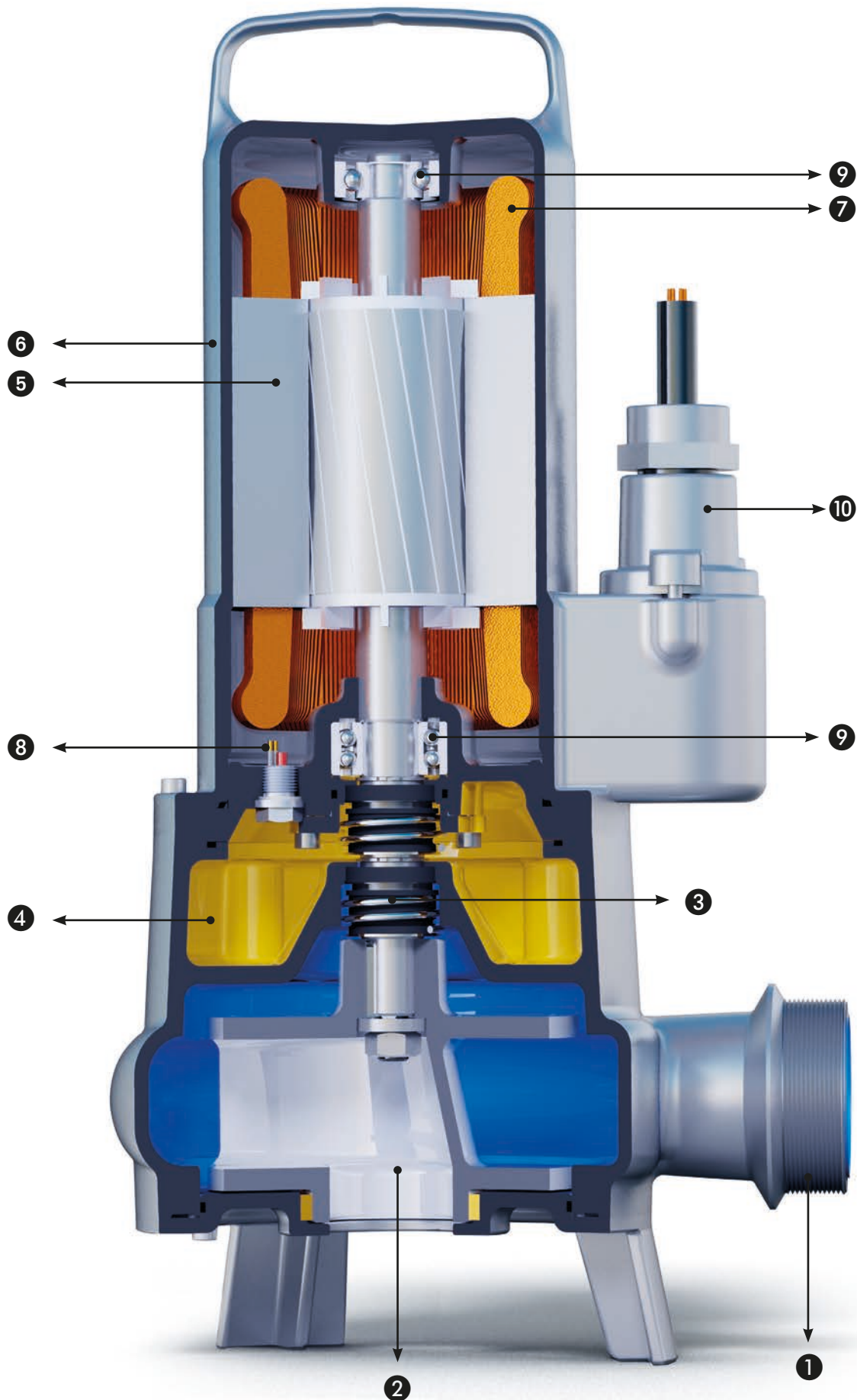

Shown model: CTP 50

HIGH QUALITY MATERIALS - HIGH IMMUNITY

Quality can be measured – HOMA submersible waste water pumps are characterized by the robust design, generous dimensioning and high quality materials of all components.

1 DISCHARGE

G2 M / G2½ M or with DIN/ANSI flange DN 80 (CTP 70).

2 NON-CLOGGING IMPELLERS

- Open multi channel impeller (CH)
- Enclosed single channel impeller (CTP) with replaceable wear ring

3 SHAFT SEALS

Two independently working silicon-carbide mechanical seals in tandem-arrangement.

4 OIL CHAMBER

Separate large oil chamber, lubricating and cooling the mechanical seals, forming an extra safety and inspection element. Additional electronic seal condition monitoring probe on request.

5 MOTOR

Pressure tight electric motor with 2-pole winding, CTP also available with 4-pole winding. Insulation class H, protection IP 68.

EXPLOSION PROTECTION

In addition to the standard version, selected motors are also available explosion proof according to ATEX EX II 2 G Ex c d II B T4,(T3).

6 MOTOR COOLING

Motors for submerged operation, cooled by the surrounding liquid.

7 THERMAL SENSOR (BI-METAL)

Embedded in the motor winding. PTC sensors available on request.

8 MOTOR MONITORING

Electronic seal condition probe for oil chamber or moisture monitoring in stator chamber on request.

9 SHAFT BEARING

Maintenance-free, prelubricated ball bearings.

10 PRESSURE SEALED, STRAIN RELIEF CABLE ENTRY

MATERIALS

Motor housing	Stainless steel / 1.4436 (AISI 316) 1.4571 (AISI 316)
Pump housing	Stainless steel / 1.4436 (AISI 316) 1.4571 (AISI 316)
Impeller	Stainless steel / 1.4436 (CH, CTP50, CTP70) 1.4517 (Duplex) (CTP 70)
Wear ring	Stainless steel / 1.4571 (CTP)
Motor shaft	Stainless steel / 1.4462 (Duplex)
Shaft seals	Silicon-carbide / Silicon-carbide, FPM (Viton)
O-Rings	FPM (Viton)
Cable	H07RN8-F (PLUS), protection hose



RANGES AND PUMP TYPES: CV(X) - CMXS - CK

MOTOR SELECTION

Speed:

For the standard hydraulic range, the motors are designed with the following speeds.

- 2900 rpm = 2-pole
- 1450 rpm = 4-pole
- 960 rpm = 6-pole

Voltages:

All specified data relate to an operating voltage of 400V/3 Ph, 50 Hz. Different voltages are available on request.

Type of starting:

The motors are supplied as standard:

- up to 3,5 kW (P2) for DOL starting
- above 3,5 kW (P2) for DOL and star-delta starting

On request all motors are available for operating with frequency converter or soft starter device.

Explosion protection:

In addition to the standard version, selected motors are also available explosion proof according to ATEX EX II 2 G Ex c d II B T4,(T3).

Motor monitoring:

All motors are supplied with temperature sensors in the winding, bi-metallic sensors (standard) or PTC sensors (on request).

Motors for wet well installation:

With oil barrier chamber monitoring probe. Optionally with moisture monitoring of the cable connection chamber (version S).

Motor with cooling jacket:

Supplied as standard with oil chamber seal condition monitoring probe.

Additional monitoring devices (bearing temperature, stator room moisture) on request.

PUMP TYPE CODE: CV(X) - CMXS - CK

Range	Impeller	Discharge	Spherical clearance	Impeller diameter	Motor frame size	Motor power (coded)	Speed	Monitoring	Explosion protection
Pumpe					Motor				
C	MXS	2	4	48-	T	6	4	(S)	(EX)
C = stainless steel	MXS = enclosed single channel V(X) = Vortex K = enclosed multi channel	1 = 80 mm 2 = 100 mm 3 = 150 mm	(mm : 25) 3 = 80 mm 4 = 100 mm	(mm : 5) e.g. 48 = 240 mm	C, D, T, P,		2 = 2-pole (2900 rpm) 4 = 4-pole (1450 rpm) 6 = 6-pole (960 rpm)	C = Oil chamber seal condition monitoring probe S = moisture sensor in stator chamber	

RANGES AND HYDRAULICS

HYDRAULIC SELECTION

Discharge and suction flange

- DN 80
- DN 100
- DN 150

Reducing adapters for different auto-coupling system and valve dimensions are available.

Impeller:

A range of different impeller designs are available to provide optimum performance and reliability with various liquids and operating conditions.

Impeller spherical clearance:

The pumps are available with impeller spherical clearances from 80 mm to 100 mm according to pump range.



CMXS
Enclosed Single Channel Impeller

For liquids containing impurities and sludge with solid particles or long fibers. New generation of non clogging impellers with hydraulic efficiency over 80%.



CK
Enclosed Multi Channel Impeller

For liquids containing impurities and sludge with solid particles.



CV(X)
Vortex Impeller

For liquids containing a high level of impurities or fibrous matter and containing gas.

DESIGN - PROVEN QUALITY IN DETAIL

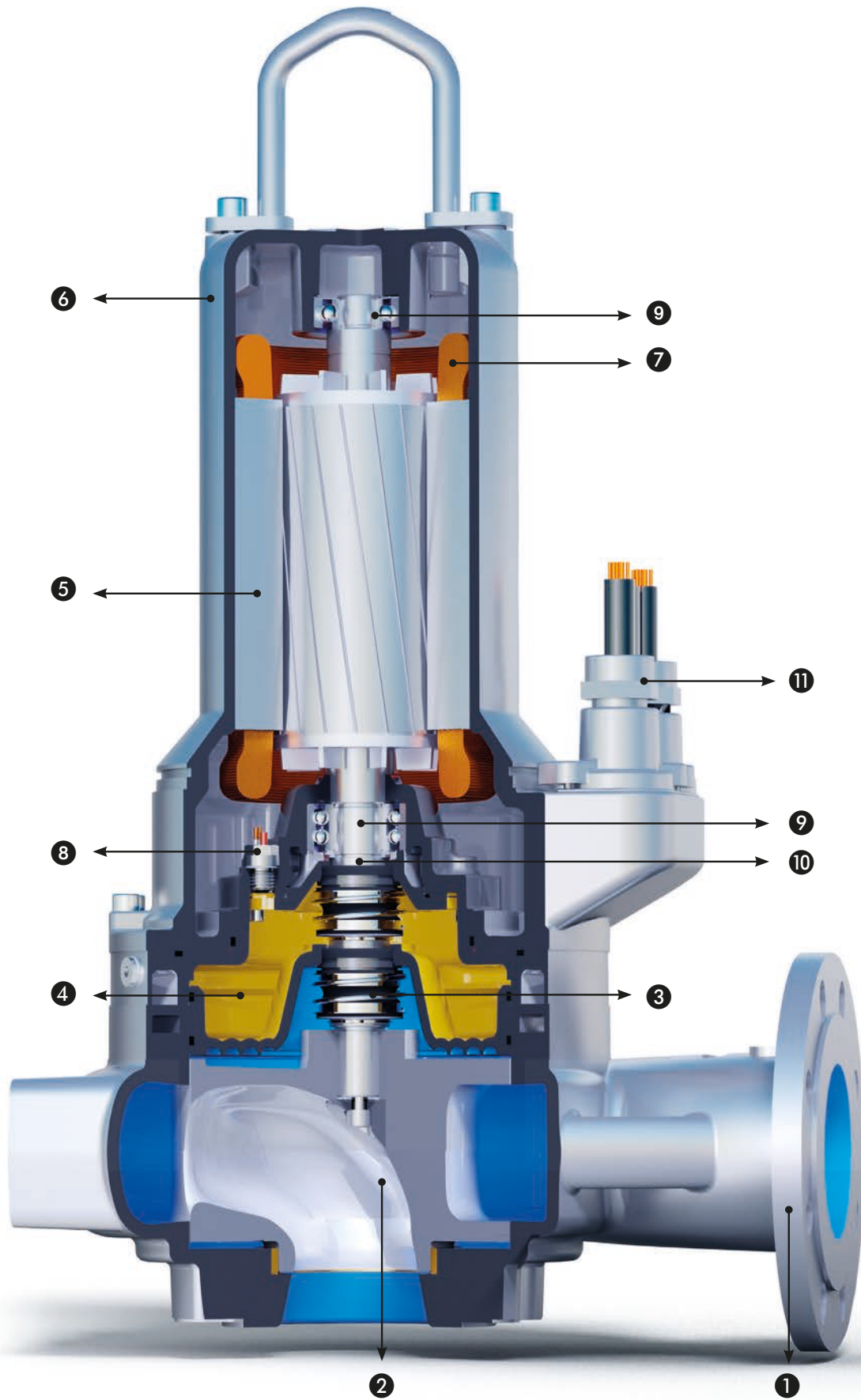

Shown model: CMXS2448-T64C

HIGH QUALITY MATERIALS - HIGH IMMUNITY

Quality can be measured – HOMA submersible waste water pumps are characterized by the robust design, generous dimensioning and high quality materials of all components.

1 DISCHARGE

With DIN/ANSI flange DN 80, DN 100 or DN 150 (PN 10)

2 NON-CLOGGING IMPELLERS

With large spherical clearance

- Enclosed single channel impeller with replaceable wear ring
- Enclosed multi channel impeller with replaceable wear ring
- Vortex impeller

3 SHAFT SEALS

Two independently working silicon-carbide mechanical seals in tandem-arrangement.

4 OIL CHAMBER

Oil-filled sealing chamber with screw for inspection. All motors with seal monitoring in the oil barrier chamber as standard.

5 MOTOR

Three phase electric motor with 2-, 4- or 6-pole winding. Insulation class H (180 C), Protection IP 68

EXPLOSION PROTECTION

In addition to the standard version, selected motors are also available explosion proof according to ATEX EX II 2 G Ex c d II B T4,(T3).

6 MOTOR COOLING

Motors for submerged operation, cooled by the surrounding liquid (standard).

7 THERMAL SENSOR (BI-METAL)

Embedded in the motor winding. PTC sensors available on request.

8 MOISTURE MONITORING IN STATOR CHAMBER

On request.

9 SHAFT BEARING

Maintenance-free, prelubricated ball bearings.

10 TEMPERATURE MONITORING OF THE SHAFT BEARINGS

On request.

11 PRESSURE SEALED, STRAIN RELIEF CABLE ENTRY

MATERIALS

Motor housing	Stainless steel / 1.4436 (AISI 316)
Pump housing	Stainless steel / 1.4408 (AISI 316) 1.4517 (Duplex)
Impeller	Stainless steel** / 1.4408 (AISI 316) 1.4517 (Duplex)
Wear ring	Stainless steel / 1.4571 (AISI 316)
Motor shaft	Stainless steel / 1.4462 (Duplex)
Mechanical seals*	Silicon-carbide / Silicon-carbide, FPM (Viton)
Cooling jacket	Stainless steel / 1.4571 (AISI 316)
Elastomers	FPM (Viton)
Cable	H07RN8-F (PLUS), protection hose

* encapsulated seals on request ** also available in bronze

PUMP RANGES SELECTION CHART

G2 / G2½ M

Open multi channel impeller
10 mm Ø
spherical clearance
2800 rpm



CH... -2 pole

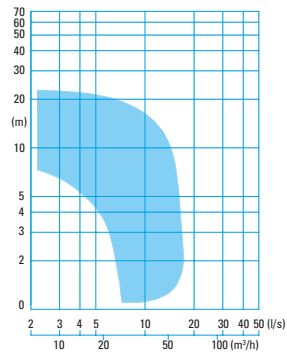

G2½

Enclosed single channel impeller
50 mm Ø
spherical clearance
2800 rpm / 1450 rpm



CTP... -2 + 4 pole

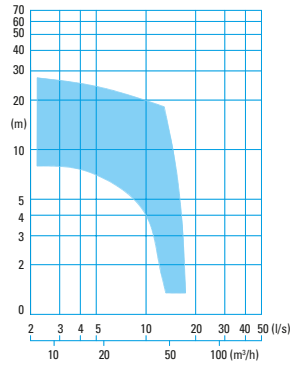

DN 80

Enclosed single channel impeller
70 mm Ø
spherical clearance
1450 rpm



CTP... -4 pole

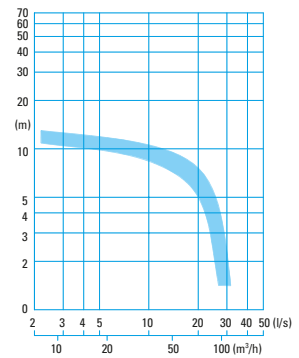

DN 80

Enclosed single channel impeller
80 mm Ø
spherical clearance
2900 rpm



CMXS 13... -2 pole

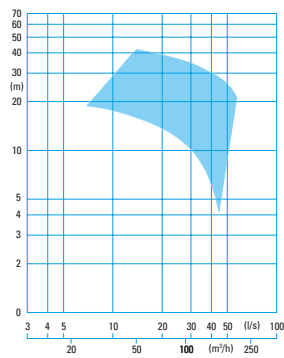

DN 80

Enclosed single channel impeller
80 mm Ø
spherical clearance
1450 rpm



CMXS 13... -4 pole

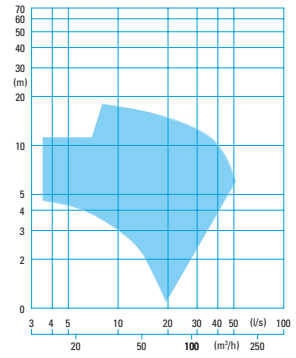

DN 80

Vortex impeller
80 mm Ø
spherical clearance
2900 rpm



CV 13... -2 pole

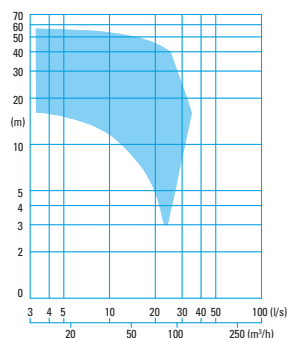

DN 80

Vortex impeller
80 mm Ø
spherical clearance
1450 rpm



CV(X) 13... -4 pole

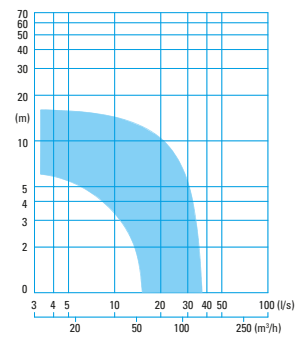

PUMP RANGES SELECTION CHART

DN 100

Enclosed Single channel
impeller
80 mm Ø
Spherical clearance
2900 rpm



CMXS 23... -2 pole

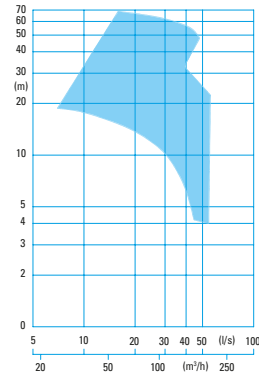

DN 100

Enclosed Single channel
impeller
80 mm Ø
Spherical clearance
1450 rpm



CMXS 23... -4 pole

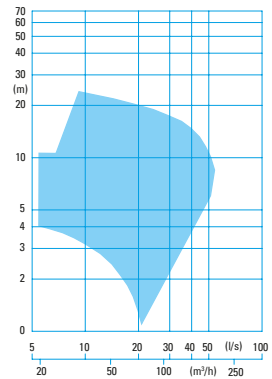

DN 100

Enclosed single channel
impeller
100 mm Ø
spherical clearance
1450 rpm



CMXS 24... -4 pole

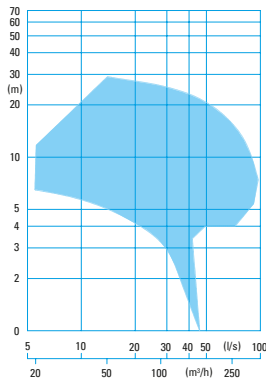

DN 100

Enclosed single channel
impeller
100 mm Ø
spherical clearance
960 rpm



CMXS 24... -6 pole

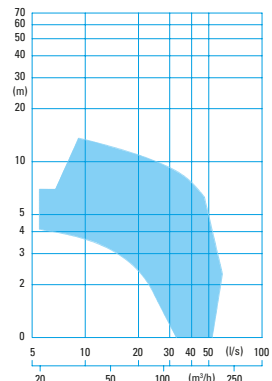

DN 150

Enclosed single channel
impeller
100 mm Ø
spherical clearance
1450 rpm



CMXS 34... -4 pole

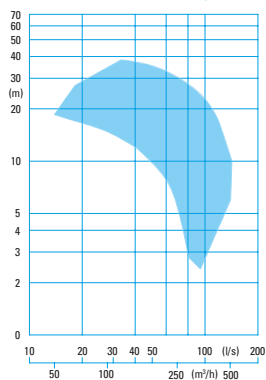

DN 150

Enclosed multi channel
impeller
80 mm Ø
spherical clearance
1450 rpm



CK 33... -4 pole

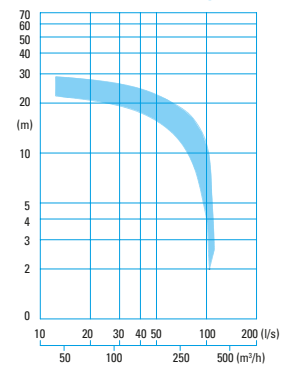



Stainless steel mixers CHRS

Areas of application for HOMA submersible mixers of the CHRS series are municipal and industrial wastewater treatment, industrial processing, agriculture and many others. The robust design of the mixers assure trouble-free operation even under the most demanding conditions. The hydraulically optimized design of propeller and motor unit results in outstanding efficiency and excellent mixing performance with minimal flow losses.



HOMA Product Range

- Submersible waste water pumps
- Deep-well submersible pumps
- Submersible sewage pumps
- Submersible grinder pumps with cutter system
- Waste water disposal units
- Sewage disposal units
- Packaged pump stations
- Mixers
- Injector systems for tank cleaning
- Garden pumps and domestic booster units
- Control boxes



Worldwide Presence

HOMA pumps are installed in more than 100 countries around the world – in countless projects of various kinds. They comply to all international safety and quality standards and are certified by many institutions and organisations responsible for national waste water treatment standards. To maintain and further develop this high quality level is our main target.

HOMA Pumpenfabrik GmbH

Industriestraße 1 ➤ 53819 Neunkirchen-Seelscheid

Telefon: +49(0)2247/702-0 ➤ Fax: +49(0)2247/702-44

e-Mail: info@homa-pumpen.de ➤ Internet: www.homapumps.com

