

Rotating cleaning nozzle Whirly 2 Series 5W9



Features:

- Popular and proven design
- Cleaning with effective flat jets
- Various connection options
- Available with a wide range of flow rates and spray angles



ATEX version available on request

Series 5W9

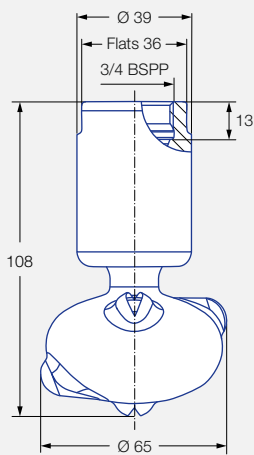

Female thread

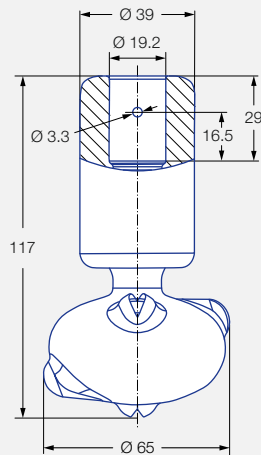

Dimensions slip-on connection according to ASME-BPE (OD-tube)

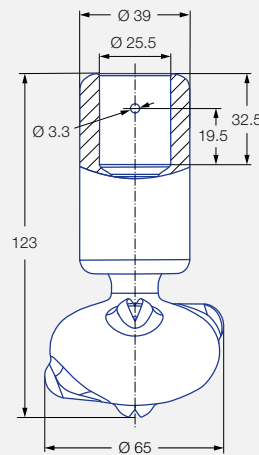

Dimensions slip-on connection according to ASME-BPE (OD-tube)

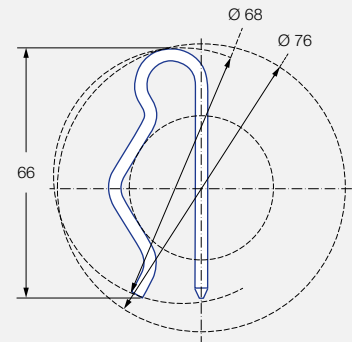

Dimensions slip-on connection top view

Max. tank diameter [m]	0	1	2	3	4	5	6	7	8	9



Cleaning efficiency class
3



Max. temperature
140°C



Installation
Operation in every direction is possible



Bearing
Double ball bearing made of stainless steel



Material
Stainless steel 316L, PEEK



Recommended operating pressure
2 bar





Filtration
Line strainer with a mesh size of 0.1 mm/170 mesh



Adapter
3/4 BSPP is compatible with HygienicFit

Function video
www.lechler.com/de-en/medialibrary
 Or scan the QR Code.



Spray angle	Ordering no.				Narrowest free cross section \varnothing [mm]	\dot{V} water [l/min]				Max. tank diameter [m]
	Type	Code				p [bar] ($p_{max} = 6$ bar)				
		3/4 BSPP	3/4" Slip-on connection	1" Slip-on connection		1.0	2.0	3.0	at 40 psi [US gal/min]	
270° 	5W9.075.1Y	AL	TF07	TF10	2.0	34	48	59	15	1.8
	5W9.145.1Y	AL	TF07	TF10	2.8	50	71	87	22	2.1
	5W9.195.1Y	AL	TF07	TF10	3.3	69	97	119	30	2.6
270° 	5W9.076.1Y	AL	TF07	TF10	2.0	34	48	59	15	1.8
	5W9.106.1Y	AL	TF07	TF10	2.5	41	58	71	18	2.1
	5W9.196.1Y	AL	TF07	TF10	3.4	69	97	119	30	2.6
360° 	5W9.079.1Y	AL	TF07	TF10	1.6	34	48	59	15	1.8
	5W9.149.1Y	AL	TF07	TF10	2.4	50	71	87	22	2.1
	5W9.199.1Y	AL	TF07	TF10	3.0	69	97	119	30	2.6
	5W9.279.1Y	AL	TF07	TF10	3.5	103	145	178	45	3.0

NPT thread available on request.

The maximum tank diameter applies to the recommended operating pressure and is meant as a recommendation only. The cleaning result is also affected by the type of soiling.

Compressed air should be used for dry blowing for a short time only. Operation above the recommended operating pressure has a negative impact on the cleaning result and wear.

Information about slip-on connections

- Pin made of stainless steel 316L supplied (Ordering no.: 095.013.1Y.06.72.0).
- Depending on the diameter of the adapter, the flow rate can increase due to a leakage between the adapter and the rotating cleaning nozzle.
- Minimum insertion diameter (with mounted pin) is 68 mm.

Ordering	Type	+	Code	=	Ordering no.
example:	5W9.075.1Y	+	AL	=	5W9.075.1Y.AL