

WILLBRANDT

The Compensator Catalogue

Product Description
Technical Data
Advice on Application
Calculation Criteria

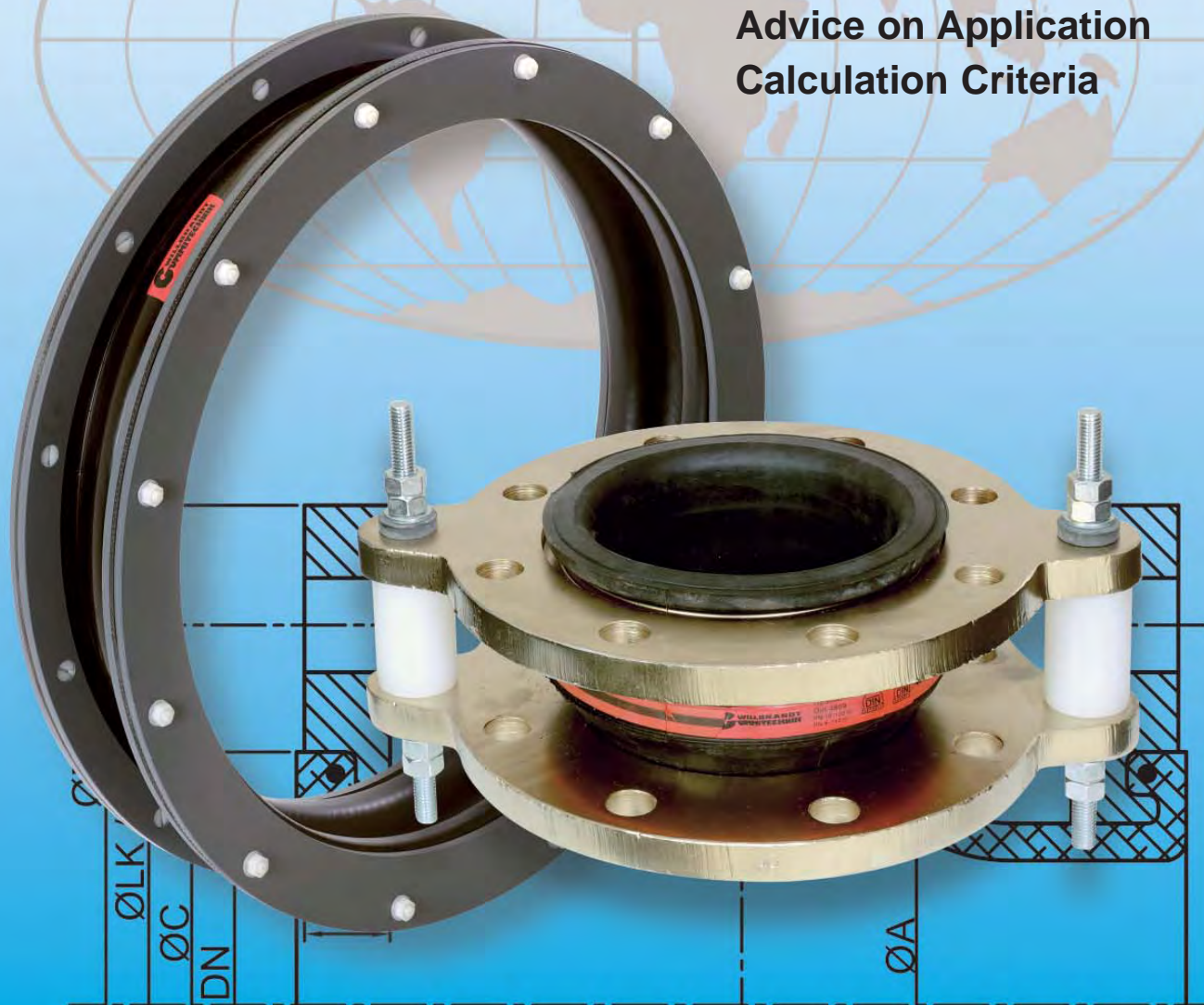

Contents

Summary of Compensators	3
Bellow Construction	4
Rubber qualities, reinforcing materials and max. application range for various bellow types	
Material Description	5
Compensators	6
Type 39	6
Type 40	8
Type 42	15
Type 45	17
Type 46	18
Type 48	20
Type 49	21
Type 50	25
Type 51	31
Type 53	32
Type 54	33
Type 55	34
Type 56	36
Type 57	37
Type 58	39
Type 59	40
Type 60	41
Type 61	42
Type 62	43
Type 63	44
Type 64	45
Type 80	47
Type 80 HD	49
Tie Bars / Restraints	50
Special Parts	52
Flameproof protective covers, deflector sleeve, earth cover safety compensator, pressure balanced compensator	
Stainless Steel Compensators	54
Standard range overview	
Stainless Steel Hose Hype 310 / 311	56
Fabric Compensator Hype 300-GEW	59
Planning, Installation and Maintenance Instructions	60
Flange Bolt Torques (Nm)	68
Installation and Maintenance Instructions for Type 64	71
Spacer for Install Rubber Expansion Joints with Slip-on Flanges	71
Installation Instructions for Type 80	72
Sealing Profile of the Rubber Bellows	73
Flange Mating Dimensions	74
Creating a movement diagram	75

Summary of Compensators

Type 39 DN-range 50 - 1000
Overall length (mm) variable

Fields of Application
Shipbuilding, Industrial Plants,
Repair/Substitute

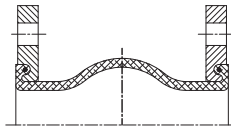

Type 40 DN-range 200 - 5000
Overall length (mm) 200 - 450

Fields of Application
Power Stations, Commercial
Plants, Purification Plants,
Pipelines

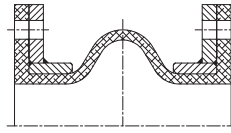

Type 42 DN-range 50 - 4000
Overall length (mm) 145 - 450

Fields of Application
Shipbuilding, Paper Industry,
Hydraulic Systems, Power
Stations

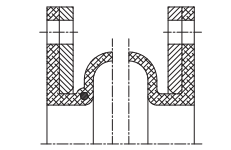

Type 45 DN-Range 20 - 50
Overall length (mm) 120 - 155

Fields of Application
Housing Technology, Motor
Technology, Air Conditioning System,
Sprinkler System

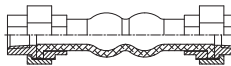

Type 46 DN-range 20 - 50
Overall length (mm) 130

Fields of Application,
Housing Technology,
Motor Technology

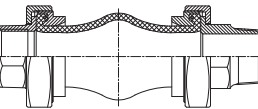

Type 48 DN-range 50 - 250
Overall length (mm) 150 - 170

Fields of Application
Steel works, Shipbuilding,
Plant Construction

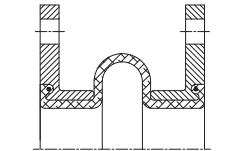

Type 49 DN-range 32 - 500
Overall length (mm) 100 - 110

Fields of Application
Housing Technology,
Shipbuilding, Plant
Construction, Gas Plants
Scales Technology

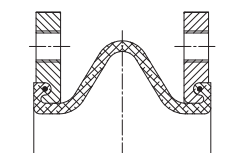

Type 50 DN-range 20 - 1000
Overall length (mm) 130 - 300

Fields of Application
Plant Construction, Gas Plants,
Housing Technology, Power
Stations

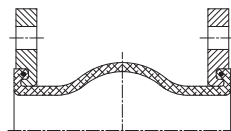

Type 51 DN-range 50 - 1000
Overall length (mm) 130 - 300

Fields of Application
Chemical Plants

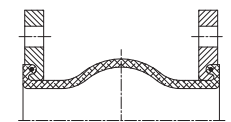

Type 53 DN-range 20 - 600
Overall length (mm) 130 - 250

Fields of Application
Plant constructions, Housing
Technology, Waterworks and
Purification Plants

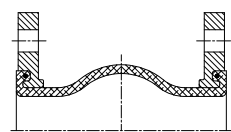

Type 54 DN-range 32 - 125
Overall length (mm) 65 - 130

Fields of Application
Hydraulic System

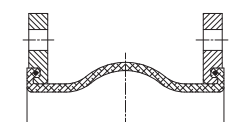

Type 55 DN-range 32 - 1000
Overall length (mm) 125 - 300

Fields of Application
Shipbuilding, Housing
Technology, Waterworks and
Purification Plants

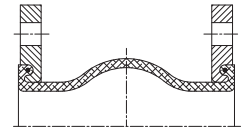

Type 56 DN-range 20 - 300
Overall length (mm) 100 - 1000

Fields of Application
Shipbuilding, Paper Industry,
Material Handling Technology,
Media Particles Solution

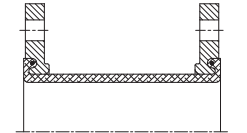

Type 57 DN-range 20 - 300
Overall length (mm) 250 - 300

Fields of Application
Shipbuilding, Paper Industry,
Material Handling Technology,
Media Particles Solution

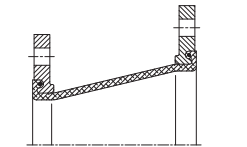

Type 58 DN-range 40 - 3000
Overall length (mm) 250 - 1000

Fields of Application
Shipbuilding, Paper Industry,
Material Handling Technology,
Media Particles Solution

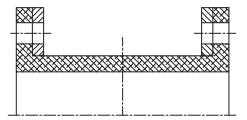

Type 59 DN-range 100 - 3000
Overall length (mm) 250 - 300

Fields of Application
Shipbuilding, Paper Industry,
Material Handling Technology,
Media Particles Solution

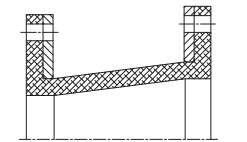

Type 60 DN-range 20 - 200
Overall length (mm) 70 - 90

Fields of Application
Housing Technology,
Industrial Plants

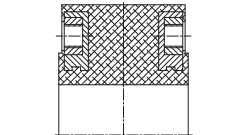

Type 61 DN-range 50 - 1000
Overall length (mm) 250

Fields of Application
Industrial Plants,
Motor Technology,
Sewage Technology

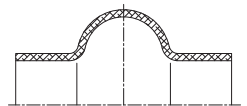

Type 62 DN-range 70 - 1000
Overall length (mm) variable

Fields of Application
Drainage Systems for Bridges,
Large Buildings



Type 63 DN-range all
Overall length (mm) variable

Fields of Application
Special hand-formed items,
Plant construction/Wall seals

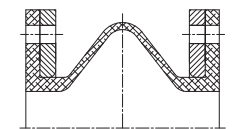

Type 64 DN-range all
Overall length (mm) variable

Fields of Application
Motor Technology, Sewage
Technology, Air Construction,
Plant construction/Wall seals

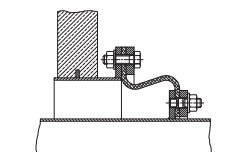

Type 80 DN-range 20 - 1200
Overall length (mm) 50 - 170

Fields of Application
Chemical Plants

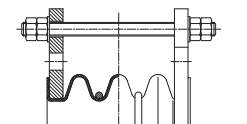

Bellow Construction

Bellow design			Bellows colour code	max. pressure / max. permissible temperature bar/°C																			
Core (inner)	Reinforcing material	Cover (outer)		Type 39	Type 40	Type 42	Type 45	Type 46	Type 48	Type 49	Type 50	Type 51	Type 53	Type 54	Type 55	Type 56 - 59	Type 60	Type 61	Type 62	Type 63	Type 64		
EPDM	Aramide/ Special cord	EPDM	red-red	25/130	25/130	80/130	/	16/100	16/110	25/130	16/130	/	/	/	16/130	6/120	10/110	6/110	/	6/110	/		
EPDM	Nylon cord	EPDM	red	16/90	16/90	16/90	10/90	16/90	16/90	/	/	/	16/90	/	16/90	10/90	6/90	6/90	3/90	6/90	0.5/120		
EPDM	Steel cord	EPDM	red-red-blue	16/130	/	16/130	/	16/110	/	/	/	/	/	/	/	/	/	/	/	/	/		
Perbunan NBR	Aramide/ Special cord	Perbunan NBR	yellow-blue	25/120	25/100	80/120	/	/	/	/	/	/	25/120	/	/	6/120	/	/	/	/	/		
Perbunan NBR	Nylon cord	Chloroprene CR	yellow	16/80	16/80	16/80	/	16/90	/	25/100	16/100	/	16/90	10/90	16/100	10/90	6/90	3/90	6/90	6/90	0.4/100		
Perbunan NBR	Nylon cord	Chloroprene CR	orange	/	16/90	/	/	16/90	/	/	25/100	/	/	/	/	/	/	/	/	/	/		
Perbunan NBR	Steel cord	Chloroprene CR	yellow-yellow	16/100	/	/	/	16/100	/	/	16/100	/	/	/	16/100	/	/	/	/	/	/		
Hypalon CSM	Aramide/ Special cord	Hypalon CSM	green-blue	25/120	25/130	80/120	/	/	/	/	/	/	16/120	/	/	10/120	/	/	/	6/120	/		
Hypalon CSM	Nylon cord	Hypalon CSM	green	16/80	16/80	16/80	/	16/90	/	25/100	16/100	/	/	/	16/100	10/90	6/90	3/90	6/90	6/90	/		
Chloroprene CR	Nylon cord	Chloroprene CR	grey	/	16/80	16/80	/	16/80	16/80	/	16/90	/	16/90	/	/	10/70	/	/	3/70	/	/		
Butyl IIR	Nylon cord	EPDM	red-blue	16/90	16/90	16/90	/	16/90	/	25/100	16/100	/	/	/	16/100	/	/	/	/	6/90	/		
Butyl IIR-D	Aramide/ Special cord	EPDM	red-blue	25/150	/	80/150	/	/	/	/	/	/	25/150	/	/	6/150	/	/	/	/	/	/	
Viton® EPM	Nylon cord	ECO	green-white-green	/	/	/	/	16/100	/	/	16/100	/	/	/	/	/	/	/	/	/	/	/	
Viton® FPM	Aramide/ Special cord	Chloroprene CR	lilac	25/120	/	80/120	/	/	/	/	/	25/120	/	/	/	/	/	6/100	/	6/120	/	/	
Viton® FPM	Aramide/ Special cord	EPDM	lilac-red	25/150	25/150	80/150	/	/	/	/	/	25/150	/	/	6/120	/	/	/	/	/	/	/	
Viton® FPM	Aramide/ Special cord	Viton FPM	lilac-lilac	/	/	/	/	/	/	/	/	/	/	/	/	/	/	/	/	/	0.5/200	/	
SI	Aramide/ Special cord	SI	/	/	25/150	/	/	/	/	/	/	/	/	/	/	/	/	/	/	6/200	0.2/200	/	

Special manufacture for higher pressure and temperature is available on request.

Important: Quoted values are max. values. The quoted pressures are valid at 50°C a decrease relative to increasing temperatures.

See resistance lists for specific temperatures.

Material Description

Abbreviation (colour code)	Name	Properties
EPDM <div style="border: 1px solid black; padding: 2px; display: inline-block;">red</div>	Ethylene-propylene-terpolymerisat	Good heat resistance and suitable for alkaline waste water, compressed air terpolymer (oil free) and chemicals, weather-resistant, good gastightness except for hydrocarbon. Temperature range -35°C up to +130°C Not suitable for oils or fatty media.
Perbunan® NBR <div style="border: 1px solid black; padding: 2px; display: inline-block;">yellow</div>	Acrylnitrile-butadiene-rubber	Oil and fuel quality, also suitable for gases, solvents and fats. High abrasion resistance. Temperature range -20°C up to +90°C (120°C) Not suitable for steam and hot water.
Perbunan® NBR <div style="border: 1px solid black; padding: 2px; display: inline-block;">orange</div>	Acrylnitrile-butadiene-rubber	Oil and fuel quality, also suitable for gases, solvents and fats and LPG acc. to DIN 51622. High abrasion resistance. Temperature range -20°C up to +90°C Not suitable for steam and hot water.
Perbunan® NBR <div style="border: 1px solid black; padding: 2px; display: inline-block;">yellow LT</div>	Acrylnitrile-butadiene-rubber	Oil and fuel quality, also suitable for gases, solvents and fats. High abrasion resistance. Temperature range -40°C up to +90°C (120°C) Not suitable for steam and hot water.
HNBR <div style="border: 1px solid black; padding: 2px; display: inline-block;">yellow-blue-yellow</div>	Acrylnitrile-butadiene-rubber	Oil and fuel quality, also suitable for gases, solvents, fats, cooling water and sea water. High abrasion resistance. Temperature range -20°C up to +90°C (120°C)
Perbunan® NBR <div style="border: 1px solid black; padding: 2px; display: inline-block;">white</div>	Acrylnitrile-butadiene-rubber	Foodstuff quality in accordance with RAL guidelines, good for pulps, fats, flours, juices and wines. Temperature range -20°C up to +90°C
Hypalon® CSM <div style="border: 1px solid black; padding: 2px; display: inline-block;">green</div>	Chloro-sulfonated polyethylen	Chemical resistant quality for acids, bases and lyes. Temperature range -20°C up to +130°C See resistance lists for specific temperatures.
Neoprene® CR <div style="border: 1px solid black; padding: 2px; display: inline-block;">grey</div>	Chloroprene rubber	Water quality, weather-resistant, suitable for some small groups of lyes as well as compressed air and lightly oil-related media. Temperature range -25°C up to +90°C
SI <div style="border: 1px solid black; padding: 2px; display: inline-block;">none</div>	Silicone-rubber	Diluted hydrochloric acids, animal and herbal oils and fats, Hydraulic fluids (HFD-R and HFD-S) Temperature range -40°C up to +200°C
Butyl® IIR <div style="border: 1px solid black; padding: 2px; display: inline-block;">red or blue</div>	Butyl-rubber	Good heat resistance, suitable for alkaline waste water, compressed air (oil free), chemicals and special hydraulic oils, weather-resistant. Temperature range -30°C up to +90°C Drinking water quality in accordance with KTW-Guidelines.
Butyl® IIR-D <div style="border: 1px solid black; padding: 2px; display: inline-block;">red/blue</div>	Butyl-rubber	Good heat resistance, suitable for alkaline waste water, compressed air (oil free), chemicals and special hydraulic oils, weather-resistant. Temperature range -25°C up to +150°C
Viton® FPM <div style="border: 1px solid black; padding: 2px; display: inline-block;">lilac</div>	Fluorine-polymer	Particularly suited to high temperatures. Good resistance to chemicals and oils, combustibles and solvents. Temperature range -20°C up to +150°C Not suitable for ketones and chlorine.
PTFE <div style="border: 1px solid black; padding: 2px; display: inline-block;">none</div>	Polytetrafluorine-ethylene	Total resistance to all media. Temperature range -50°C up to +230°C Not suitable for alkali metals in molten state and reaction-formed amides.

The indicated temperatures relate to flexible applications. In rigid applications lower temperatures can be used. For pressure and expansion details please refer to the type descriptions.

For chemical resistance please see our resistance tables.

WILLBRANDT Rubber Compensator Type 39

Type 39 is a hand-built low corrugated rubber compensator and can therefore be customised to fit in any existing gap by virtue of its variable overall length.

Design:

Low corrugated rubber bellow with reinforcing inserts and built-in packing profile for absorption of the swivel flanges.

The compensator is self-sealing, no additional gaskets are required.



Characteristics for type 39

Bellow colour code	Bellow design			Permissible operating data						Electrical resistance		Hardness shore A
	Core (inner)	Reinforcing material	Cover (outer)	bar	°C	bar	°C	bar	°C	Ohm	cm	
red-St	EPDM	Steel cord	EPDM	16	50	10	100	6	130	7 x 10 ²		60
red	EPDM	Nylon cord	EPDM	16	50	10	70	8	90	7 x 10 ²		60
yellow-St	NBR	Steel cord	CR	16	50	12	70	10	100	5 x 10 ³		60
yellow	NBR	Nylon cord	CR	10	50	10	70	10	90	5 x 10 ³		60
green-St	CSM	Steel cord	CSM	16	50	12	70	10	90	4 x 10 ¹⁰		65
green	CSM	Nylon cord	CSM	10	50	10	70	10	90	4 x 10 ¹⁰		65
white	NBR/white	Nylon cord	CR	10	50	10	70	10	80	5 x 10 ³		60
lilac	FPM	Aramide	EPDM	16	50	10	130	4	150			65

Burst pressure > 3 x max. bar

Suitable for vacuum up to 0.8 bar abs., without supporting ring

Suitable for vacuum up to 0 bar abs., with supporting ring

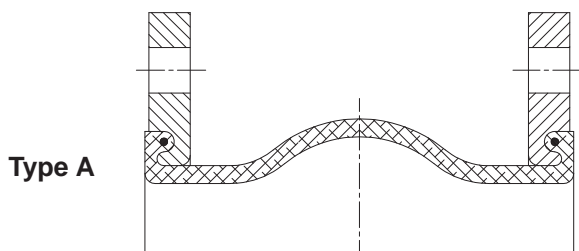

Type A

Flanges: (Design A)

Swivel flanges both sides (Design A) with integral rubber profile, so that additional gaskets are not required (self-sealing).

The flanges are drilled to DIN PN 10 as standard. Other specifications in accordance with DIN, ASA, BS and special flanges are also available.

Flange Material: Standard S 235 JRG2 (RSt 37-2) zinc plated and yellow passivated. Other materials available on request.

Vacuum supporting rings

WILLBRANDT type 39 compensators are vacuum-resistant. To prevent the compensator bellow being drawn together by suction at negative pressure, the insertion of a vacuum supporting ring is necessary for a suction value above 2 m (0.8 bar abs., 20% negative pressure).

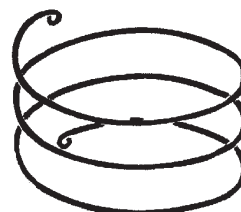

Note:

For aggressive media please refer to the resistance table. The bellow must not be painted or insulated. Further installation advices in appendix.

Accessories:

Tie bar/Restraints

Deflector sleeve

Flameproof protective cover

Earth cover

See page 50

See page 52

See page 52

See page 53

Application:

Type 39 red For drinking water / warm water
For cold and warm water, also with the addition of chemicals for water treatment. Industrial water, acids, lyes, alcohols, esters and ketones.
Not suitable for oil-related media.

Type 39 white For the food and beverage industry
Also suitable for oil- and fat-containing foodstuff.

Type 39 green For chemical plants
For heavy chemical use. Permissible temperature, working pressure and life expectancy depend on the medium and its concentration in each case.

Type 39 yellow For oil, fuel, gas
Application range: City- and natural gas, blast furnace gas, fuel, lube oil, heating oil, cooling water emulsion

Type 39 lilac For chemical plants
Particularly for higher thermal duty up to approx. 150°C.
The highest permissible load depends on a mixture of temperature, pressure, movement and life expectancy.

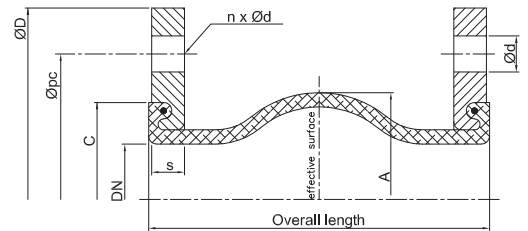

DN	Overall length mm	Bellow		Flange PN 10					Movement absorption				ØC mm
		ØA mm	Effect. surface cm ²	ØD mm	ØPC mm	Ød mm	n	s mm	axial + mm	axial - mm	lat. +/- mm	∠° +/-	
50	130 - 500	96	32	165	125	18	4	16	10	20	15	35	89
65	130 - 500	110	53	185	145	18	4	16	10	20	15	30	104
80	130 - 500	122	85	200	160	18	8	18	15	20	15	30	119
100	130 - 500	142	128	220	180	18	8	18	15	20	15	25	142
125	130 - 500	170	187	250	210	18	8	18	15	20	15	25	169
150	130 - 500	196	259	285	240	23	8	20	15	20	15	20	195
200	130 - 500	256	409	340	295	23	8	20	15	20	15	15	245
250	130 - 500	306	599	395	350	23	12	20	15	20	15	10	295
300	130 - 500	352	822	445	400	23	12	20	15	20	15	10	348
350	130 - 500	442	1080	505	460	22	16	20	15	20	15	10	412
400	150 - 500	495	1379	565	515	26	16	25	20	25	20	8	470
450	150 - 500	545	1801	615	565	26	20	25	20	25	20	8	512
500	150 - 500	595	2038	670	620	26	20	30	20	25	20	6	570
600	150 - 500	695	3286	780	725	30	20	30	20	25	20	6	675
700	150 - 500	832	4183	895	840	30	24	35	20	25	20	5	780
750	150 - 500	882	4751	-	-	-	-	35	20	25	20	4	830
800	150 - 500	932	5407	1015	950	33	24	40	20	25	20	4	887
900	150 - 500	1032	6706	1115	1050	33	28	40	20	25	20	4	985
1000	150 - 500	1134	8231	1230	1160	36	28	40	20	25	20	4	1085

Permissible % of indicated movement relative to temperature:
 up to 50°C ~ 100%
 up to 70°C ~ 75%
 up to 90°C ~ 60%

Tie bar and flange design see Annex page 50/51.

WILLBRANDT Rubber Compensator Type 40

Type 40 incorporates a highly flexible convolution with solid rubber flanges. It is characterized by its ability to compensate for high movement and its low inherent resistance.

Design:

High corrugated rubber bellow body with reinforcing inserts and integral pressure-strengthened solid rubber flanges, self-sealing, requiring no additional gaskets. One-piece steel backing flanges, with supporting collar, to ensure the smooth rolling up of the bellow.

Application:

Cooling water piping in power stations and industrial plant, desalination plants, drinking water supply, shipbuilding and in pumps, turbines and tanks, for the absorption of movements, oscillations, noise and vibrations, as well as being installed as an axial and lateral compensator for building settlement.

Max. DN 5000

Flange:

Standard design acc. to DIN PN 10, retaining flange in S 235 JRG2 (RSt. 37-2) hot-dip galvanized. Other materials and drillings are possible on request.

Overall lengths:

The indicated overall lengths are standard lengths and can be altered (multi-corrugated design for higher expansion compensation possible).



Details for type 40

Bellow identification marking	Core	Reinforcing material	Cover	Pressure (max.) bar	Temperature (max.) °C
red	EPDM	Nyloncord	EPDM	18	90
red/red	EPDM	Aramide	EPDM	27	130
blue	EPDM Tw/black	Nyloncord	EPDM	18	90
white	EPDM Tw/white	Nyloncord	EPDM	18	90
grey	CR	Nyloncord	CR	18	70
green	CSM	Nyloncord	CSM	18	90
green/red	CSM	Aramide	CSM	27	130
yellow	NBR	Nyloncord	NBR	18	90
yellow/red	NBR	Aramide	NBR	27	100
yellow/yellow	H NBR	Aramide	H NBR	27	130
lilac	FPM	Nyloncord	EPDM	18	90
lilac	FPM	Aramide	EPDM	27	150
	SI	Glass Fabric	SI	3	200
	SI	Aramide	SI	27	150

The pressure indication states a max. value which depends on the lengths and nominal widths (see chart page 9 and 10) burst pressure >50 bar.

All compensators can be delivered with a compensation of potential. Suitable for vacuum up to 0.8 bar abs., without supporting ring (2m suction height). Suitable for vacuum up to 0 bar abs., with supporting ring (10m suction height). The bellows can be manufactured with vulcanized PTFE foil to achieve a higher chemical resistance. On request vacuum rings can be vulcanized in the bellow (no vacuum or medium contact). Flange connections will be manufactured on request in all versions, e.g. PN6, PN10, PN16, ANSI B 16.5 class 150, ANSI B 16.47 class 150.

The steel retaining flanges will be designed according to the pressure with or without supporting collar. The preloading flanges will be calculated according to the operating pressure (versions see page 50/51).

Pressure resistance type 40 short length (can be extended and shortened on request)

DN	Overall length	Effective area length	Wave inner	Thick-ness of steel flange	Reinforcing material					
					Rubber flange pressure (max.)				Expansion	
					Nylon		Aramide		axial +/-	lateral +/-
					at 10 mm	at 13 mm	at 15 mm	at 15 mm		
mm	cm ²	mm	mm	bar	bar	bar	bar	mm	mm	
200	150	504	260	12	8.5	17.0	25.5	38.3	10/25	20
250	150	717	310	12	8.2	16.4	24.6	36.9	25/10	20
300	150	977	362	12	8.0	16.0	24.0	36.0	25/10	20
350	150	1223	405	12	7.9	15.7	23.6	35.4	25/10	20
400	200	1733	482	15	6.2	12.4	18.5	27.8	20/35	30
450	200	2119	533	15	6.1	12.2	18.3	27.5	20/35	30
500	200	2535	583	15	6.0	12.1	18.1	27.2	35/20	30
550	200	2988	633	15	6.0	11.9	17.9	26.9	35/20	30
600	200	3479	683	15	5.9	11.8	17.8	26.7	35/20	30
650	200	3974	730	15	5.9	11.8	17.6	26.4	35/20	30
700	200	4584	784	15	5.8	11.7	17.5	26.3	35/20	30
750	200	5137	830	15	5.2	11.6	17.4	26.1	35/20	30
800	250	5867	887	15	5.2	10.5	15.7	23.6	35/20	30
850	250	6478	932	15	5.2	10.4	15.6	23.4	35/20	30
900	250	7265	987	15	5.2	10.4	15.6	23.4	35/20	30
950	250	7942	1032	15	5.2	10.3	15.5	23.3	35/20	30
1000	250	8812	1087	15	5.1	10.3	15.4	23.1	35/20	30
1050	250	9556	1132	20	5.1	10.3	15.4	23.1	35/20	30
1100	300	11045	1217	20	4.3	8.6	12.9	19.4	30/40	40
1150	300	11877	1262	20	4.3	8.6	12.9	19.4	40/30	40
1200	300	12935	1317	20	4.3	8.6	12.9	19.4	40/30	40
1250	300	13834	1362	20	4.3	8.6	12.8	19.2	40/30	40
1300	300	14974	1417	20	4.3	8.5	12.8	19.2	40/30	40
1350	300	15940	1462	20	4.3	8.5	12.8	19.2	40/30	40
1400	300	17162	1517	20	4.2	8.5	12.7	19.1	40/30	40
1450	300	18195	1562	20	4.2	8.5	12.7	19.1	40/30	40
1500	300	19499	1617	20	4.2	8.5	12.7	19.1	40/30	40
1600	300	21985	1717	20	4.2	8.4	12.6	18.9	40/30	40
1650	300	23153	1762	20	4.2	8.4	12.6	18.9	40/30	40
1700	300	24621	1817	20	4.2	8.4	12.6	18.9	40/30	40
1800	300	27405	1917	20	4.2	8.4	12.6	18.9	40/30	40
1950	300	31708	2062	20	4.2	8.3	12.5	18.8	40/30	40
2000	300	33422	2117	20	4.2	8.3	12.5	18.8	40/30	40
2100	300	36654	2217	20	4.2	8.3	12.5	18.8	40/30	40
2150	300	38157	2262	20	4.2	8.3	12.5	18.8	40/30	40
2200	300	40036	2317	20	4.2	8.3	12.5	18.8	40/30	40
2250	300	41606	2362	20	4.1	8.3	12.4	18.6	40/30	40
2300	300	43566	2417	20	4.1	8.3	12.4	18.6	40/30	40
2400	300	47245	2517	20	4.1	8.3	12.4	18.6	40/30	40
2500	300	51074	2617	25	4.1	8.3	12.4	18.6	40/30	40
2550	300	52846	2662	25	4.1	8.3	12.4	18.6	40/30	40
2600	300	55052	2717	25	4.1	8.2	12.4	18.6	40/30	40
2700	300	59179	2817	25	4.1	8.2	12.4	18.6	40/30	40
2800	300	63455	2917	25	4.1	8.2	12.3	18.5	40/30	40
2850	300	65428	2962	25	4.1	8.2	12.3	18.5	40/30	40
2900	300	67880	3017	25	4.1	8.2	12.3	18.5	40/30	40
3000	300	72455	3117	25	4.1	8.2	12.3	18.5	40/30	40

max. DN 5000

Pressure resistance type 40 standard lengths (can be extended on request - also two-corrugated)

DN	Overall length	Effective area at length	Wave inner	Thick-ness of steel flange	Reinforcing material					
					Rubber flange pressure (max.)			Expansion		
					Nylon		Aramide	axial +/-		lateral +/-
mm	cm ²	mm	mm	at 10 mm	at 13 mm	at 15 mm	at 15 mm	mm	mm	
					bar	bar	bar	bar		
200	200	627	290	12	6.8	13.6	20.4	30.6	20/35	30
250	200	717	310	12	6.6	13.2	19.7	29.6	35/20	30
300	200	977	362	12	6.4	12.8	19.2	28.8	35/20	30
350	200	1223	405	12	6.3	12.6	18.9	28.4	35/20	30
400	250	1733	482	15	5.6	11.3	16.9	25.4	35/20	30
450	250	2119	533	15	5.5	11.1	16.6	24.9	35/20	30
500	250	2535	583	15	5.5	11.0	16.4	24.6	35/20	30
550	250	2988	633	15	5.4	10.8	16.3	24.5	35/20	30
600	250	3479	683	15	5.4	10.7	16.1	24.2	35/20	30
650	250	3974	730	15	5.3	10.7	16.0	24.0	35/20	30
700	250	4584	784	15	5.3	10.6	15.9	23.9	30/40	40
750	250	5137	830	15	5.3	10.5	15.8	23.7	40/30	40
800	300	5867	887	15	4.4	8.9	13.3	20.0	40/30	40
850	300	6478	932	15	4.4	8.8	13.2	19.8	40/30	40
900	300	7265	987	15	4.4	8.8	13.2	19.8	40/30	40
950	300	7942	1032	15	4.4	8.7	13.1	19.7	40/30	40
1000	300	8812	1087	15	4.3	8.7	13.0	19.5	40/30	40
1050	300	9556	1132	20	4.3	8.7	13.0	19.5	40/30	40
1100	350	11045	1217	20	3.4	6.8	10.1	15.2	40/30	40
1150	350	11877	1262	20	3.4	6.7	10.1	15.2	40/30	40
1200	350	12935	1317	20	3.4	6.7	10.1	15.2	40/30	40
1250	350	13834	1362	20	3.3	6.7	10.0	15.0	40/30	40
1300	350	14974	1417	20	3.3	6.7	10.0	15.0	40/30	40
1350	350	15940	1462	20	3.3	6.6	10.0	15.0	40/30	40
1400	350	17162	1517	20	3.3	6.6	9.9	14.9	40/30	40
1450	350	18195	1562	20	3.3	6.6	9.9	14.9	40/30	40
1500	350	19499	1617	20	3.3	6.6	9.9	14.9	40/30	40
1600	350	21985	1717	20	3.3	6.6	9.8	14.7	40/30	40
1650	350	23153	1762	20	3.3	6.6	9.8	14.7	40/30	40
1700	350	24621	1817	20	3.3	6.5	9.8	14.7	40/30	40
1800	350	27405	1917	20	3.3	6.5	9.8	14.7	40/30	40
1950	350	31708	2062	20	3.2	6.5	9.7	14.6	40/30	40
2000	350	33422	2117	20	3.2	6.5	9.7	14.6	40/30	40
2100	350	36654	2217	20	3.2	6.5	9.7	14.6	40/30	40
2150	350	38157	2262	20	3.2	6.4	9.7	14.6	40/30	40
2200	350	40036	2317	20	3.2	6.4	9.7	14.6	40/30	40
2250	350	41606	2362	20	3.2	6.4	9.7	14.6	40/30	40
2300	350	43566	2417	20	3.2	6.4	9.6	14.4	40/30	40
2400	350	47245	2517	20	3.2	6.4	9.6	14.4	40/30	40
2500	350	51074	2617	25	3.2	6.4	9.6	14.4	40/30	40
2550	350	52846	2662	25	3.2	6.4	9.6	14.4	40/30	40
2600	350	55052	2717	25	3.2	6.4	9.6	14.4	40/30	40
2700	350	59179	2817	25	3.2	6.4	9.6	14.4	40/30	40
2800	350	63455	2917	25	3.2	6.4	9.6	14.4	40/30	40
2850	350	65428	2962	25	3.2	6.4	9.5	14.3	40/30	40
2900	350	67880	3017	25	3.2	6.4	9.5	14.3	40/30	40
3000	350	72455	3117	25	3.2	6.4	9.5	14.3	40/30	40

max. DN 5000

Stiffness rate axial for type 40 (average value by full way)

DN	Overall length mm	0 bar N/mm	1 bar N/mm	2,5 bar N/mm	4 bar N/mm	6 bar N/mm	10 bar N/mm
200	200	45	79	90	144	216	360
250	200	51	88	107	166	246	405
300	200	56	98	118	180	269	454
350	200	73	129	153	239	350	599
400	250	40	70	83	131	190	322
450	250	48	85	102	152	235	389
500	250	55	99	118	171	265	457
600	250	68	119	136	218	326	544
700	250	70	121	147	228	338	557
750	250	72	126	151	232	346	583
800	250	73	129	153	239	350	599
900	300	95	169	202	300	466	770
1000	300	136	245	291	422	656	1129
1100	350	210	399	462	756	1130	1865
1200	350	240	458	538	876	1277	2136
1400	350	245	463	532	902	1316	2193
1500	350	255	492	587	944	1403	2295
1600	350	310	597	685	1138	1668	2821
1700	350	390	662	818	1468	2142	3569
1800	350	480	926	1051	1819	2616	4416
2000	350	690	1339	1546	2512	3830	6314
2100	350	835	1607	1879	2998	4676	7690
2200	350	910	1747	2029	3367	4969	8099
2400	350	1050	1995	2363	3812	5691	9450

Attention: Variations in stiffness rate are possible by material reinforcing or production process change with +/-25%.

Stiffness rate lateral for type 40 (average value by full way)

DN	Overall length mm	0 bar N/mm	1 bar N/mm	2,5 bar N/mm	4 bar N/mm	6 bar N/mm	10 bar N/mm
200	200	200	330	366	428	540	616
250	200	220	370	407	475	605	686
300	200	250	425	470	545	695	783
350	200	280	482	529	610	781	882
400	250	180	315	347	400	513	576
450	250	190	338	371	420	536	604
500	250	200	330	366	428	540	616
600	250	235	388	430	503	635	724
700	250	310	521	574	670	853	967
750	250	310	527	583	676	862	970
800	250	340	585	643	741	949	1071
900	300	360	641	702	796	1015	1145
1000	300	380	673	749	956	1083	1216
1100	350	395	612	683	901	1067	1217
1200	350	440	724	783	1025	1197	1390
1400	350	480	763	878	1133	1330	1526
1500	350	530	885	1002	1261	1479	1707
1600	350	645	1109	1238	1548	1819	2090
1700	350	710	1304	1378	1723	2118	2355
1800	350	775	1418	1519	1899	2217	2519
2000	350	890	1682	1816	2225	2563	2919
2100	350	886	1692	1852	2304	2596	2835
2200	350	1050	2016	2226	2940	3150	3465
2400	350	1360	2638	3128	3944	4284	4529

Attention: Variations in stiffness rate are possible by material reinforcing or production process change with +/-25%.

Permissible compound expansion compensation

Compound Movements
Axial and lateral loads

$$\text{Permissible lateral} = \text{Max. lateral} \left(1 - \frac{\text{effective axial}}{\text{max. axial}} \right)$$

For compound movements the axial and lateral paths are reduced accordingly.

Example: Compensator Type 40 DN 1200
PN 10 flange according to tab. 2
Overall length 350 mm, axial movements +/-10mm
max. permissible deflection

Solution : Permissible lateral = $30 \left(1 - \frac{10}{25} \right) = 18$

= +/- 18 mm permissible lateral load,
Installation length 335 mm



restraint compensator - design M DN 2600

Restraint:

Under pressure the compensator bellow produces a reaction force (in the axial direction [effective surface area x operating pressure]), which must be absorbed by the nearest anchor-points.

For purely lateral or angular movement it is possible, with restraints (see tie bar page 50) to relieve the anchor-points or mounting point connections of the reaction force, so that only the adjusting forces from the extension movement still have to be absorbed.

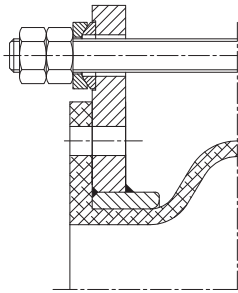

Restraint
Design E

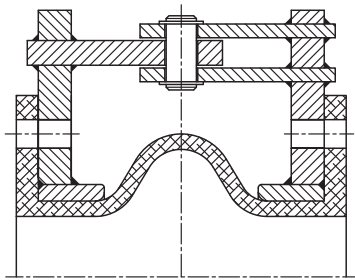

Hinged arrangement
Design F

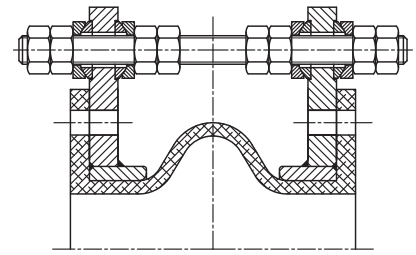

Restraint
Design M

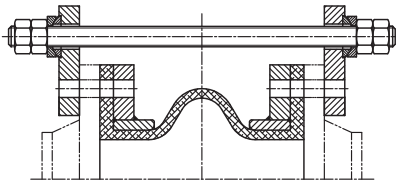

With external tie bar
Design K

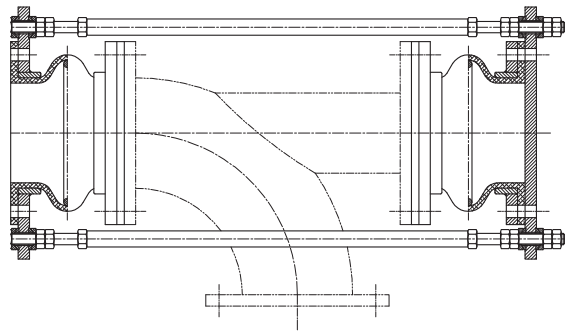

pressure balanced compensator

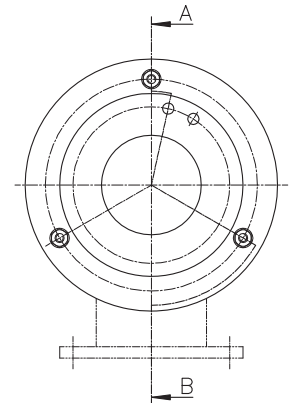

Important Note:

Counter flanges must be designed smooth and without recesses.
The bellow must not be insulated or painted.
See installation information, page 60.

WILLBRANDT Rubber Compensator Type 42

Type 42 is a robust, thick-walled rubber compensator with integrated corrugation produced by hand winding.

The manufacturing process makes it possible to produce this compensator in variable overall lengths and pressure ratings.

Design:

Synthetic rubber body with various reinforcing inserts and fully strengthened rubber flanges with or without steel insert. The rubber flange is self-sealing so that no additional gasket is required.



Details for type 42

Bellows colour code	Bellow design			Permissible operating data		Electrical resistance [Ohm cm]	Hardness shore A
	Core (inner)	Reinforcing material	Cover (outer)	bar	°C		
red	EPDM	Nylon cord	EPDM	8	90	7×10^2	60
red/red	EPDM	Aramide	EPDM	80	130		60
yellow	NBR	Nylon cord	CR	8	90	5×10^2	60
yellow/blue	NBR	Aramide	CR	80	100		60
green	CSM	Nylon cord	CSM	8	90	4×10^4	65
white	NBR/white	Nylon cord	CR	10	80	5×10^3	55
lilac	FPM	Kevlar	EPDM	10	150		65

Burst pressure > 30 bar,
Suitable for vacuum 0.7 bar absolute, full vacuum with supporting ring.

Flange:

Both sides with pressure-strengthened solid rubber flanges, drilled according to specific requirements with one-piece steel backing flanges of material S 235 JRG 2 (R-St 37-2) with corrosion protection.

- Design I with loose backing flanges
- Design II with vulcanized backing flanges
- Design III with loose backing flanges and supporting collar
- Design IV with vulcanized backing flanges and in the bellow vulcanized steel rings

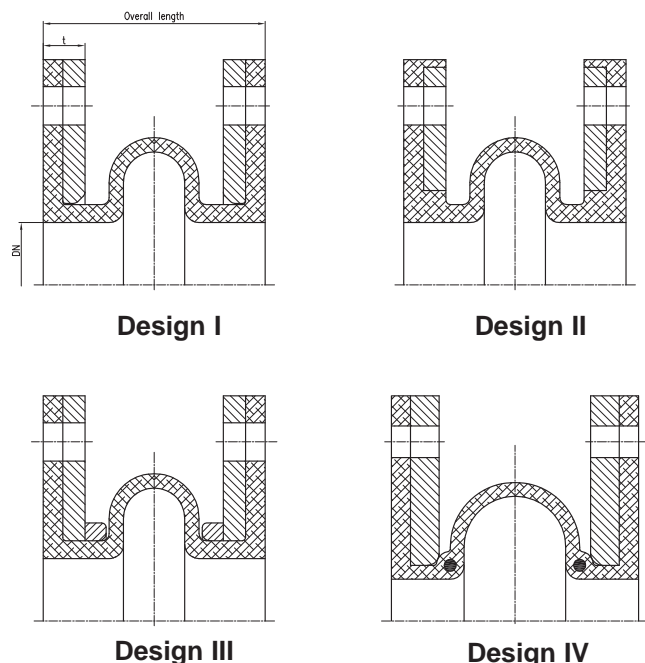

Note:

For aggressive media, see resistance table.

The bellow must not be painted or insulated.
See installation information in Annex.

DN		Standard overall length mm	Variable overall length mm	t rubber and steel mm	Movement absorption for the standard				Standard pressure bar	Max. pressure bar
					ax + mm	ax - mm	lat ± mm	∠ ±°		
50	2"	150	150 - 500	25	10	20	10	10.0	10	80
65	2 1/2"	200	150 - 500	25	10	20	20	10.0	10	80
80	3"	200	150 - 500	25	10	20	20	10.0	10	80
100	4"	200	150 - 500	25	10	25	20	10.0	10	80
125	5"	200	150 - 500	25	10	25	20	10.0	10	50
150	6"	200	150 - 500	25	10	25	20	10.0	10	50
175	7"	200	150 - 500	25	15	25	20	10.0	10	50
200	8"	200	150 - 500	25	15	25	20	10.0	10	50
225	9"	200	200 - 500	25	15	25	20	10.0	10	50
250	10"	200	200 - 500	25	15	25	20	8.0	10	40
300	12"	200	200 - 500	25	15	25	20	8.0	10	40
350	14"	250	200 - 500	25	15	30	25	5.0	10	40
400	16"	250	200 - 500	25	15	30	25	8.0	10	40
450	18"	250	200 - 500	25	30	30	25	8.0	10	40
500	20"	250	200 - 500	25	30	30	25	7.0	10	40
550	22"	250	200 - 500	25	30	30	25	7.0	10	40
600	24"	250	200 - 500	25	30	30	25	5.0	10	40
650	26"	250	200 - 500	25	30	30	25	5.0	10	40
700	28"	250	200 - 500	25	30	30	25	4.0	10	40
750	30"	250	200 - 500	25	30	30	25	4.0	10	40
800	32"	300	250 - 500	32	30	30	25	4.0	10	40
850	34"	300	250 - 500	32	30	30	25	4.0	10	40
900	36"	300	250 - 500	32	30	30	25	3.0	10	40
1000	40"	300	250 - 500	32	30	30	25	3.0	10	40
1050	42"	350	250 - 500	32	30	35	25	3.0	10	20
1100	44"	350	250 - 500	35	30	35	25	3.0	10	20
1150	46"	350	250 - 500	35	30	35	25	3.0	10	20
1200	48"	350	250 - 500	35	30	35	25	2.5	10	20
1250	50"	350	250 - 500	35	30	35	25	2.5	10	20
1300	52"	350	250 - 500	35	30	35	25	2.5	10	20
1350	54"	350	250 - 500	35	30	35	25	2.5	10	20
1400	56"	350	250 - 500	35	30	35	25	2.0	10	20
1500	60"	350	250 - 500	35	30	35	25	2.0	10	20
1600	64"	350	250 - 500	35	30	35	25	2.0	10	20
1700	68"	350	250 - 500	35	30	35	25	1.5	10	20
1800	72"	350	250 - 500	35	30	35	25	1.5	6	20
1900	76"	350	250 - 500	35	30	35	25	1.3	6	20
2000	80"	350	250 - 500	35	30	35	25	1.3	6	20
2100	84"	350	250 - 500	40	30	35	25	1.2	6	20
2200	88"	350	250 - 500	40	30	35	25	1.2	6	20
2300	92"	350	250 - 500	40	30	35	25	1.0	6	20
2400	96"	350	250 - 500	40	30	35	25	1.0	6	20
2500	100"	350	250 - 500	40	30	35	25	0.8	4	20
2600	104"	350	250 - 500	40	30	35	25	0.8	4	20
2800	112"	350	250 - 500	40	30	35	25	0.7	4	20
3000	120"	350	250 - 500	40	30	35	25	0.7	4	20
3200	128"	350	250 - 500	40	25	30	20	0.6	4	20
3400	136"	350	250 - 500	50	25	30	20	0.6	4	20
3500	140"	350	250 - 500	50	25	30	20	0.5	4	20
3600	144"	350	250 - 500	50	25	30	20	0.5	4	16
3800	152"	350	250 - 500	50	25	30	20	0.4	4	16
4000	160"	350	250 - 500	50	25	30	20	0.4	4	16

***Note:** Our bellows, type 42, are manufactured in four different flange designs. The pressure indicated in the chart is the max. possible manufacturing technical operating pressure. However, the bellows are manufactured specifically to the operating pressure stated in the order.

WILLBRANDT Rubber Compensator Type 45

Type 45 is a low corrugated rubber compensator with good noise absorbing characteristics and high expansion absorption in all three planes. Because of its low corrugation, with outstanding noise and vibration absorbing qualities as well as high expansion absorption in all directions a very low adjusting force is possible.

Design:

Low two-corrugated rubber bellow with nylon-reinforcing inserts and integral sealing bead (therefore - self-sealing without additional gasket) for accommodating three-piece unions (DIN 2999 conical). Available with or without solid-ring between the corrugations externally.

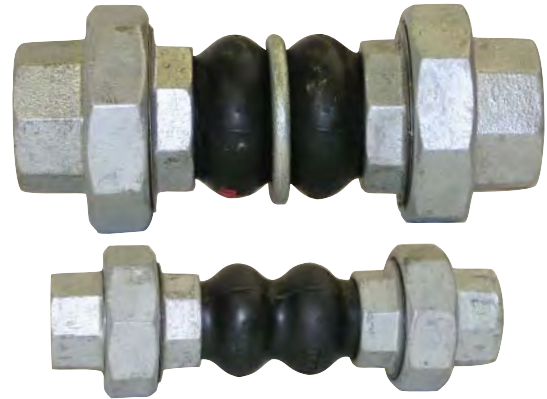

Connections:

Type 45 red both sides: With malleable cast iron, galvanized unions

Type 45 blue both sides: With red brass/brass or high-grade steel unions

Type 45 blue with drinking water approval acc. to KTW

Details for type 45

Bellow colour code	Core inner	Reinforcing material	Cover outer	Permissible operating data						Vacuum	Hardness shore A
				bar	°C	bar	°C	bar	°C		
red	EPDM	Nylon	EPDM	10	-20	10	90	6	95	0.5 bar abs.	60
blue	EPDM Tw	Nylon	EPDM	10	-20	10	90	6	95	0.5 bar abs.	60

DN	Bellow		Connection				Movement absorption				Weight kg
	Overall length mm	ØA mm	GL mm	SW1 mm	SW2 mm	R inch	ax + mm	ax - mm	lat ± mm	∠ ± °	
20	155	39	200	50	33	3/4	6	22	22	45	0.7
25	140	49	200	62	40	1	6	22	22	45	1.1
32	140	55	200	73	50	1 1/4	6	22	22	45	1.5
40	130	63	200	82	56	1 1/2	6	22	22	45	1.9
50	120	76	200	95	70	2	6	22	22	45	2.6

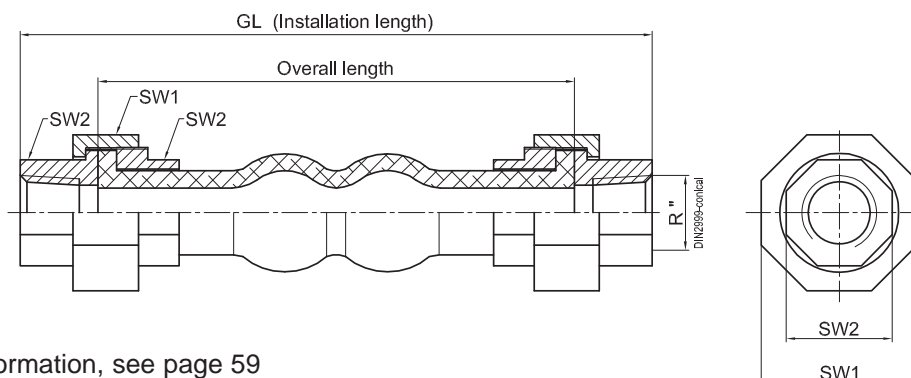

For installation information, see page 59

WILLBRANDT Rubber Compensator Type 46

Type 46, in a low corrugated high pressure design, is suitable for sanitary, heating, air-conditioning and swimming pool use, as well as for solar technology. Also for apparatus, pipeline and motor construction.

It absorbs thermal expansions and vibration, compensates for axial and lateral movements, and is resistant to chemical and mechanical stresses.

Approvals:

Type 46 red/St. and red/Sp with TÜV approval for heating systems in accordance with DIN 4809.



PED 97/23/EG

Details for type 46

Bellow colour code	Bellow design			Permissible operating data						Electrical resistance		Hardness shore A
	Core (inner)	Reinforcing material	Cover (outer)	bar	°C	bar	°C	bar	°C	Ohm	cm	
red/Sp	EPDM	Aramide	EPDM	16	50	10	100	6	110	7 x 10 ²		60
red/St	EPDM	Steel cord	EPDM	16	50	10	100	6	110	7 x 10 ²		60
blue	IIR	Nylon cord	EPDM	10	50	8	70	6	85	7 x 10 ²		55
yellow	NBR	Nylon cord	CR	16	50	12	70	10	90	5 x 10 ³		65
grey	CR	Nylon cord	CR			16	70			5 x 10 ¹⁰		60
red	EPDM	Nylon cord	EPDM	16	50	12	70	10	90	7 x 10 ²		65
white	NBR	Nylon cord	CR	16	50	12	70	10	80	5 x 10 ³		60
green	CSM	Nylon cord	CSM	16	50	12	70	10	90	5 x 10 ³		65

Burst pressure >50 bar, suitable for 0.5 bar abs.

Construction:

Low corrugated rubber expansion joint with reinforcing inserts and built-in sealing profile with rear mounted female thread for mating to threaded connecting pieces, with male or female threaded joints.

The compensator bellow bead is self-sealing.

No additional gaskets are required.
(Seal threaded joints in piping as usual)

Connecting pieces:

Type 46 white: Malleable cast iron, galvanized union nut with MS or RG thread.

Other types 46: Union nut and screw-in parts from galvanized malleable cast iron. Special connections in stainless steel are possible.

Bracing:

Under pressure the compensator bellow develops a reaction force in the axial direction. This force has to be reduced by adequate anchor points or restraints fastened on the piping.

Important note:

Ensure torsion-free installation.
The bellow must not be insulated or painted.

For installation information, see page 60.

Application:

Type 46 red aramide For heating systems, in acc. with DIN 4809
red-steelcord With corrosion-protected aramide inserts. For long service life in heating and hot water at 100°C/110°C and 10 bar/6 bar pressure for 10 year service life. Not suitable for oil-related media.

Type 46 blue nylon For drinking water / warm water
 For cold and hot water (up to 85°C), also with the addition of chemicals for water treatment. Industrial water, acids, lyes, alcohols, esters and ketones. Not suitable for oil-related media.

Type 46 white For food processing and beverage industry
 Also suitable for oil-related and fatty foodstuff. Suitable up to +80°C.

Type 46 red For warm water
 For cold and hot water (up to 90°C), also with the addition of chemicals for water treatment. Industrial water, acids, lyes, alcohols, esters and ketones. Not suitable for oil-related media.

Type 46 green For chemical plants
 For heavy chemical use up to 16 bar working pressure. Permissible temperature, working pressure and life expectancy depend in individual cases on medium and concentration. Resistance table on request.

Type 46 yellow yellow-steel cord
 Electroconductive, $R = 10^3$ up to 10^6 Ohm. Application: town- and natural gas. Blast-furnace, fuels, lubricants, heating oil, cooling water emulsions.

Type 46 grey For water pipes
 For cold and warm water, washing water, sea water, swimming pool water, waste water (also oil-related, weak acid or alkaline with CR).

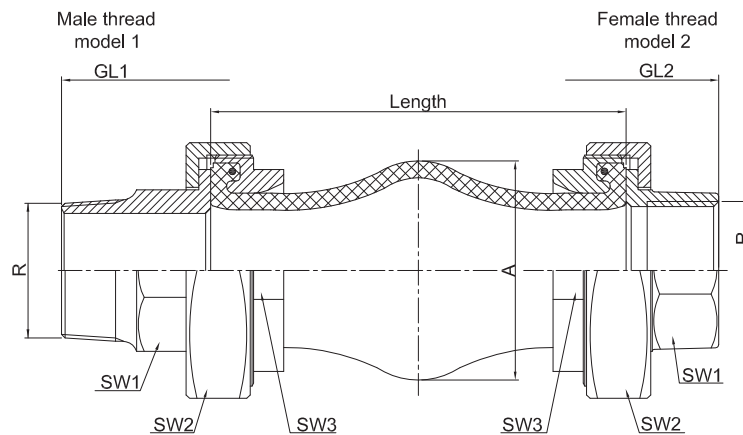

DN	Overall length mm	Bellow			Overall length		Width across Flats			Expansion absorption Reinforcing Nyloncord				Expansion absorption Reinforcing Steelcord				Weight	
		ØA mm	Effec. surface cm²	R thread	GL ₁ mm	GL ₂ mm	SW ₁ mm	SW ₂ mm	SW ₃ mm	axial		lat. +/- mm	∠ ° +/-	axial		lat. +/- mm	∠ ° +/-	Des. 2	Des. 1
										+	-			+	-			kg	kg
20	130	55	8	3/4"	228	186	36	80	48	15	30	10	30	10	15	8	30	0.70	0.60
25	130	65	12	1"	236	192	40	80	54	15	30	10	30	10	15	8	30	1.00	0.80
32	130	78	18	1 1/4"	240	190	48	80	66	15	30	10	30	10	15	8	30	1.50	1.20
40	130	90	27	1 1/2"	246	196	53	90	74	15	30	10	30	10	15	8	30	1.70	1.40
50	130	109	42	2"	254	200	66	110	90	15	30	10	30	10	15	8	30	2.60	2.20

WILLBRANDT Rubber Compensator Type 48

Type 48 is a high corrugation rubber compensator with very good noise absorbing characteristics and high expansion absorption in all three planes.

Design:

High corrugated rubber bellow with reinforcing inserts and integral sealing bead (therefore self-sealing without additional gasket) to suit the steel-backed swivel flanges with solid ring support. The flanges are provided with through-holes (PN6, PN10, PN16, ASA150 lbs, etc.). All steel parts in S235 JRG2 (RSt 37-2) are zinc-plated and yellow passivated.

Other specifications in acc. with DIN, ASA, BS Special flanges are available. (PN6, PN10, PN16, ASA 150 lbs or others).

All steel parts in S 235 JRG2 (RSt 37-2) are zinc plated and yellow passivated.

Application:

Type 49 for hot water plants and lyes



Details for type 48

Bellow colour code	Core inner	Reinforcing material	Cover outer	Permissible operating pressure						Electrical resistance [Ohm cm]	Hardness shore A
				bar	°C	bar	°C	bar	°C		
red	EPDM	Sp. Cord	EPDM	16	50	10	70	6	100	7*10 ⁴	55

DN	Bellow		Flange PN 10					Movement absorption				ØC
	Overall length mm	ØA mm	ØD mm	ØPC mm	Ød mm	n	s mm	ax + mm	ax - mm	lat ± mm	∠ ± °	
50	150	135	165	125	18	4	16	25	25	20	30	96
65	150	150	185	145	18	4	16	25	25	20	30	116
80	150	170	200	160	18	8	18	25	25	20	30	133
100	155	200	220	180	18	8	18	40	30	25	30	153
150	155	250	285	240	23	8	20	45	35	25	20	203
200	160	295	340	295	23	8	20	45	35	25	20	261
250	160	345	395	350	23	12	20	45	35	25	20	310

Special designs

With tie-rods design B as axial stroke limitation and for absorption of the reaction forces. With tie-rods design C as axial stroke and thrust limitation, tie-rods beared in rubber bushes.

WILLBRANDT Rubber Compensator Type 49

Type 49 is a heavy duty rubber compensator of a highly flexible design. Its high corrugation allows an extremely short overall length with excellent noise and vibration absorbing characteristics as well as high expansion absorption in all directions at very low movement forces.

Design:

High corrugated bellow body with integral sealing profile (therefore self-sealing without additional gasket) for mating with swivel flanges. The flanges are provided with threaded holes as the bellow is supported on the flange.



Details for DN 32 - DN 80

Bellow colour code	Bellow colour ring	Design of the bellow			Permissible operating pressure				Short-term C°	Electrical resistance [Ohm cm]
		Core inner	Reinforcing material	Cover outer	°C bar	°C bar	°C bar	°C bar		
A red	red-red	EPDM	Aramide	EPDM	-40 16	70 20	100 16	120 10	150	3 x 10 ³
blue	red	IIR	Nylon cord	EPDM	-40 16	50 20	70 16	100 10	120	7 x 10 ⁶
yellow	yellow	NBR	Nylon cord	CR	-20 16	50 20	70 16	90 10	100	1 x 10 ²
white	white	NBR	Nylon cord	CR	-20 16	50 20	70 16	90 10	100	1 x 10 ⁹
green	green	CSM	Nylon cord	CSM	-20 16	50 20	70 16	100 10	110	3 x 10 ¹¹
black EPDM		IIR	Nylon cord	EPDM	-40 10	50 10	70 8	100 6	110	7 x 10 ⁶

Suitable for vacuum up to 0.8 bar abs. without supporting ring (2 m suction)

Suitable for vacuum up to 0 bar abs. with supporting ring (10 m suction)

All compensators can be delivered with earthing straps.

Details for DN 100 - DN 500

Bellow colour code	Bellow colour ring	Design of the bellow			Permissible operating pressure				Short-term C°	Electrical resistance [Ohm cm]
		Core inner	Reinforcing material	Cover outer	°C bar	°C bar	°C bar	°C bar		
A red	red-red	EPDM	Aramide	EPDM	-40 16	70 25	100 18	120 12	150	3 x 10 ³
blue	red	IIR	Nylon cord	EPDM	-40 16	50 25	70 18	100 12	120	7 x 10 ⁶
yellow	yellow	NBR	Nylon cord	CR	-20 16	50 25	70 18	90 12	100	1 x 10 ²
white	white	NBR	Nylon cord	CR	-20 16	50 25	70 18	90 12	100	1 x 10 ⁹
green	green	CSM	Nylon cord	CSM	-20 16	50 25	70 18	100 12	110	3 x 10 ¹¹
black EPDM		IIR	Nylon cord	EPDM	-40 10	50 10	70 8	100 6	110	7 x 10 ⁶

Suitable for vacuum up to 0.8 bar abs. without supporting ring (2 m suction)

Suitable for vacuum up to 0 bar abs. with supporting ring (10 m suction)

All compensators can be delivered with earthing straps.

PED 97/23/EG



Approvals:

- Type 49 A-red **with TÜV/DIN 4809** for heating installation, Technical Control Number **3 E001**
- Type 49 white with quality assurance as per DIN 7725 Suitable for foodstuff - RAL-C 53
- Type 49 blue with Drinking Water Approval RAL-C 52 and 1986 Federal Health Bureau KTW Rubber Committee
- Type 49 all Ship Licence with or without flame protective cover, depending on installation location.

Flange: (Design A)

Swivel flanges on both sides with integral rubber profile, so that an additional gasket is not required (self-sealing). The flange holes are DIN PN 10 standard, with threaded bolt-holes. Other flange specifications in accordance with DIN, ASA, BS. Special flanges are also available.

The flange is produced with appropriate threaded holes; through-bolts cannot be used.

Flange material:

Standard S 235 JRG2 (RSt37-2) zinc plated and yellow passivated.

Other materials available on request.

Application:

Type 49 A-red For heating systems, as per DIN 4809
For continuous duty in warm and hot water heating at 100 °C/110 °C and 10bar/6bar working pressure over life.
Not suitable for oil-related media.

Type 49 blue For drinking water / warm water
For cold and warm water, also with the addition of chemicals for water treatment. Industrial water, acids, lyes, alcohols, esters and ketones. Not suitable for oil-related media.

Type 49 white For the food and beverage industry
Also suitable for oil- and fat-containing foodstuff.

Type 49 green For chemical plants
For heavy chemical use.

Type 49 yellow For oil, fuel, gas
Application range: natural and town gas, blast furnace gas, fuels, lubricants, heating, cooling water emulsions.

Type 49 black For water pipes
For cold and warm water, water with detergents, sea water, swimming pool water, waste water.
Not suitable for oil-related media.

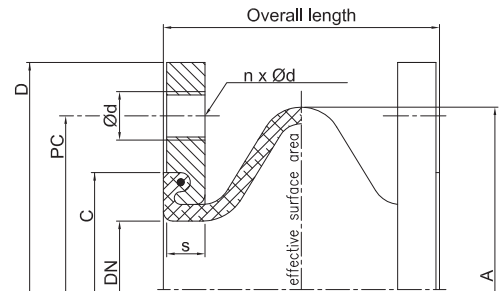

DN	Overall length mm	Bellows		Flange PN 10					Movement absorption				ØC mm	Weight kg
		ØA mm	Eff. sur- face cm ²	ØD mm	ØPC mm	Ød	n	s mm	axial + mm	axial - mm	lat. +/- mm	∠ ° * +/-		
32	100	110	18	140	100	M16	4	16	20	30	30	7	79	3.0
40	100	110	18	150	110	M16	4	16	20	30	30	7	79	3.6
50	100	120	35	165	125	M16	4	16	20	30	30	7	89	4.4
65	100	135	56	185	145	M16	4	16	20	30	30	7	104	5.3
80	100	150	87	200	160	M16	8	18	20	30	30	7	119	6.5
100	100	170	130	220	180	M16	8	18	20	30	30	7	142	7.3
125	100	195	190	250	210	M16	8	18	20	30	30	7	169	8.9
150	100	260	263	285	240	M20	8	20	20	30	30	7	195	12.3
175	100	310	416	315	270	M20	8	20	20	30	30	7	245	16.2
200	100	310	416	340	295	M20	8	20	20	30	30	7	245	16.2
250	100	360	607	395	350	M20	12	20	20	30	30	7	295	20.3
300	100	410	830	445	400	M20	12	20	20	30	30	7	345	23.1
350	100	460	1100	505	460	M20	16	20	20	30	30	7	396	30.1
400	110	515	1385	565	515	M24	16	25	20	30	30	7	450	43.2
500	110	615	2091	670	620	M24	20	25	20	30	30	7	550	53.8

Permissible % of indicated movement relative to temperature:
up to 50°C ~ 100%
up to 70°C ~ 80%
up to 90°C ~ 70%

* Only valid for an assembly shortened by about 10 mm (90/100mm).

Note:
For aggressive media please refer to the resistance table.
The bellows must not be painted or insulated.
See further installation information in Annex.

Accessories:

Tie bar/Restraints See page 50
Deflector sleeve See page 52
Flameproof protective covers See page 52
Earth Covers See page 53

Tie bar (Standard Designs B + C):

Since the rubber bellow is a soft flexible component, it must be observed that under pressure the compensator will always try to move in the axial direction because of its reaction force (cross section area x working pressure).

It must be ensured by constructive measures on the piping (roller bearing, restraining or anchor points) or tie bars directly on the compensator that any over-extension of the bellow is avoided.

See our range of tie bars on pages 50/51.

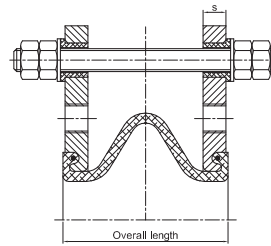

Design B

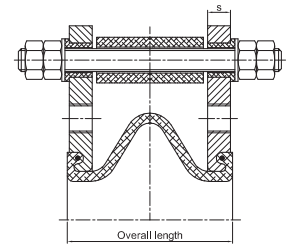

Design C

Flange shapes for tie bars as per designs B and C at 10 bar

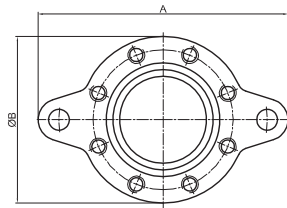

DN 25 - 200

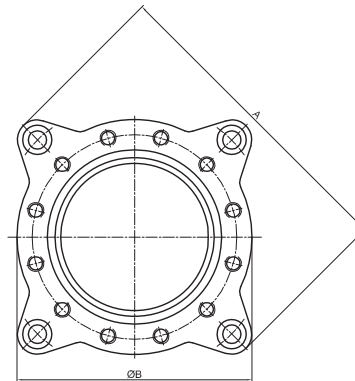

DN 250 - 500



DN	Main dimension for PN 10			
	Overall length mm	s mm	A mm	ØB mm
32	100	16	230	140
40	100	16	240	150
50	100	16	255	165
65	100	16	275	185
80	100	18	290	200
100	100	18	310	220
125	100	18	340	250
150	100	20	375	285
175	100	20	405	315
200	100	20	440	340
250	100	20	509	395
300	100	20	559	445
350	100	20	619	505
400	110	25	700	565
500	110	25	810	670

Vacuum Supporting Rings:

WILLBRANDT type 49 compensators are suitable for vacuum. To prevent the compensator bellow being drawn together by suction at negative pressure, the insertion of a vacuum supporting ring is necessary for a pressure above 2m (0.8bar abs., 20% negative pressure).

DN	Art-No.
32 / 40	2149305132
50 / 65	2149305150
80 / 100 / 125	2149305212
150	2149305215
175 / 200	2149305217
250	2149305225
300	2149305230
350	2149305235
400	2149305240
500	2149305250

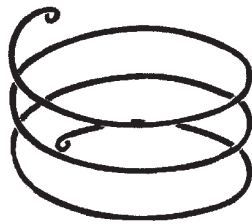

Bolt Packs SU:

Hexagon bolts according to DIN 933/8.8
Washers DIN 125

Selected bolt packs are available for connecting type 49 compensators to piping, so that by using DIN flanges, the bolt lengths are flush with the compensator bellow.

For installation, ensure smooth, burr-free surfaces on the rubber bellow using the U-washers for length correction (place under bolt head).

Accessory bolt packs			
DN	DIN-Norms		
	PN6	PN10	PN16
32	SU 1	SU 2	SU 2
40	SU 1	SU 2	SU 2
50	SU 1	SU 3	SU 3
65	SU 1	SU 3	SU 3
80	SU 4	SU 7	SU 7
100	SU 4	SU 7	SU 7
125	SU 5	SU 6	SU 6
150	SU 6	SU 10	SU 10
175	SU 6	SU 10	SU 10
200	SU 8	SU 10	SU 11
250	SU 9	SU 13	SU 17
300	SU 11	SU 14	SU 18
350	SU 12	SU 15	SU 19
400	SU 15	SU 19	SU 21
500	SU 16	SU 20	SU 22

Contents					
Bolt pack	Quantity	Bolts		Quantity	U-Washers
		kg	DIN 933/8.8		
SU 1	0.35	8	M 12X30	8	13
SU 2	0.62	8	M 16X30	8	17
SU 3	0.67	8	M 16X35	8	17
SU 4	0.68	8	M 16X35	16	17
SU 5	1.4	16	M 16X35	16	17
SU 6	1.5	16	M 16X40	16	17
SU 7	1.55	16	M 16X40	32	17
SU 8	2.6	16	M 16X45	16	17
SU 9	2.4	24	M 16X45	48	17
SU 10	2.7	16	M 20X45	16	21
SU 11	4.1	24	M 20X45	24	21
SU 12	4.2	24	M 20X45	48	21
SU 13	4.3	24	M 20X50	48	21
SU 14	4.2	24	M 20X50	24	21
SU 15	5.8	32	M 20X50	64	21
SU 16	7.3	40	M 20X50	80	21
SU 17	6.7	24	M 24X50	48	25
SU 18	6.6	24	M 24X50	24	25
SU 19	9.3	32	M 24X55	64	25
SU 20	11.7	40	M 24X55	80	25
SU 21	13.5	32	M 27X60	64	28
SU 22	22.0	40	M 30X60	80	31

WILLBRANDT Rubber Compensator Type 50

Type 50 is a low corrugated bellow compensator with good sound insulating characteristics for structure and liquid-borne noise. It is characterized by a very high expansion capability, particularly in the angular plane.



Design:

Low corrugated rubber bellow with reinforcing inserts and integral sealing bead (therefore self-sealing without additional gaskets) for accommodating the swivel flanges. The flanges are provided with through holes.

Details for DN 20 - DN 600

Bellow colour code	Bellow colour ring	Design of the bellow			Permissible operating data				Short-term C°	Surface resistance Ro [Ohm cm]				
		Core (inner)	Reinforcing material	Cover (outer)	°C	bar	°C	bar			°C	bar	°C	bar
red Sp	red-red	EPDM	Aramide	EPDM	-40	10	70	16	100	10	130	8	150	3 x 10 ³
red	red	IIR	Nylon cord	EPDM	-40	10	50	16	70	12	100	10	120	7 x 10 ⁶
yellow	yellow	NBR	Nylon cord	CR	-20	10	50	16	70	12	90	10	100	2 x 10 ²
white	white	NBR	Nylon cord	CR	-20	10	50	16	70	12	90	10	100	1 x 10 ⁹
green	green	CSM	Nylon cord	CSM	-20	10	50	16	70	12	100	10	110	3 x 10 ¹¹
orange	orange	NBR	Nylon cord	CR	-20	10	50	25	70	20	90	15	100	2 x 10 ²
black EPDM		IIR	Nylon cord	EPDM	-40	10	50	10	70	8	100	6	120	7 x 10 ⁶
black	without	CR	Nylon cord	CR	-25	10	50	16	70	12	90	10	100	8 x 10 ⁸
yellow St	yellow-yellow	NBR	Stahl cord	CR	-20	10	60	16	70	12	90	10	100	7 x 10 ⁸
yellow LT	yellow LT	NBR-LT	Steel cord	CR	-40	10	50	16	70	12	90	10	100	1 x 10 ⁴
yellow HNBR	yellow-blue-yellow	HNBR	Seel lcord	CR	-35	10	60	16	70	12	100	10	120	7 x 10 ⁸
lilac	white-green-white	FPM	Steel cord	ECO	-15	10	50	16	70	12	100	10	130	-

Suitable for vacuum up to 0.8 bar abs., without supporting ring (2 m suction)
 Suitable for vacuum up to 0 bar abs., with supporting ring (10 m suction)
 DN 20 - DN 50 suitable for vacuum without supporting ring.
 All compensators can be delivered with earthing straps.

Burst pressure DN 20 - 600 > 48 bar
 Burst pressure DN 700 - 1000 > 30 bar

Details for DN 700 - DN 1000

Bellow colour code	Bellow colour ring	Design of the bellow			Permissible operating data				Short-term C°	Surface resistance Ro [Ohm cm]				
		Core (inner)	Reinforcing material	Cover (outer)	°C	bar	°C	bar			°C	bar	°C	bar
red Sp	red-red	EPDM	Aramide	EPDM	-40	8	70	10	100	7,5	130	6	150	3 x 10 ³
red	red	IIR	Nylon cord	EPDM	-40	8	50	10	70	8	100	6	120	7 x 10 ⁶
yellow	yellow	NBR	Nylon cord	CR	-20	8	50	10	70	8	90	6	100	2 x 10 ²
white	white	NBR	Nylon cord	CR	-40	8	50	10	70	8	90	6	100	1 x 10 ⁹
green	green	CSM	Nylon cord	CSM	-20	8	50	10	70	8	100	6	110	3 x 10 ¹¹
black		IIR	Nylon cord	EPDM	-25	8	50	10	70	8	90	6	100	7 x 10 ⁶

Suitable for vacuum up to 0.8 bar abs., without supporting ring (2 m suction)
 Suitable for vacuum up to 0 bar abs., with supporting ring (10 m suction)
 All compensators can be delivered with earthing straps.

Burst pressure DN 20 - 600 > 48 bar
 Burst pressure DN 700 - 1000 > 30 bar

Flanges: (Design A)

Swivel flanges both sides (Design A) with integral rubber profile, so that additional gaskets are not required (self-sealing). The flanges are drilled acc. to DIN PN 10 as standard. Other specifications in accordance with DIN, ASA, BS. Special flanges are also available.

Flange material:

Standard S 235 JRG2 (RSt 37-2) zinc plated and yellow passivated. Other materials available on request. (Flanges up to DN 200 are in some cases made with forged collars for the bellow side).



Approvals:

Type 50 red-aramide

with TÜV/DIN approval, DIN 4809 for heating installation, Technical Control Number 3 E 003

Type 50 red

with Drinking Water Approval in accordance with 1986 Federal health Bureau KTW Rubber Committee

Type 50 white

with quality assessment in accordance with DIN 7725 - suitable for foodstuff - Marine Approval with or without flame protective cover.

Type 50 all

Application:**Type 50 red Sp**

For heating systems according to DIN 4809, with corrosion-proofed aramidecord inserts for permanent use in hot water and high temperature water, cooling water and hot air. Not suitable for oil emulsive media. Resistance to weather, ageing and ozone. Temperature range -40 up to +130°C, temporarily up to 150°C, surface area electrically conductive.

Type 50 red

For drinking water, hot water with DVGW W270 and ACS approval as well as for sea water, cooling water with chemical additives for water treatment, low concentrated acids and lyes, salt solution. Resistance to weather, ageing and ozone. Temperature range -40 up to +100°C, temporarily up to 120°C, surface area electrically conductive. Not suitable for oil products of all kinds. Cooling water with additives of oil emulsive mixtures.

Type 50 black, EPDM

For drinking water with DVGW W270 approval as well as for sea water, cooling water, low concentrated acids and lyes, technical alcohols, esters and ketones. Resistance to weather, ageing and ozone. Temperature range -40 up to +90°C, temporarily up to 100°C, surface area electrically conductive, maximum pressure 10bar.

Type 50 black CR

For cold and hot water, swimming pool water, salt water, waste water, cooling water with oil emulsive corrosion protection material, oil mixture, oil emulsive compressed air. Resistance to weather, ageing and ozone. Temperature range -25 up to +90°C, temporarily up to 100°C, electrically insulating.

Type 50 white

Especially for fat-containing foodstuff, the inner rubber is in accordance with the German food law KTW. Resistance to weather, ageing and ozone. Temperature range -20 up to +90°C, temporarily up to 100°C, electrically insulating, not suitable for drinking water, inner cover light-coloured.

Type 50 green

Especially for chemical and aggressive chemical waste water, oil emulsive compressor air, regarding the media it is essential to pay attention to the media resistance table. Resistance to weather, ageing and ozone. Temperature range -20°C up to +100°C, temporarily up to 110°C, electrically insulating.

Type 50 lilac

Especially for flue gas desulfurization plant, biodiesel, good resistance to benzol, xylool, toluol and fuel with an aromatic content of more than 50% aromatic/ chlorinated carbon hydride and mineral acids. Resistance to weather, ageing and ozone. Temperature range -15°C up to +90°C, temporarily up to 130°C, electrically insulating.

Type 50 yellow

For oil, fuel, gas, fuel-ethanol mixture and DIN EN-fuel with up to 50% aromatic content. Natural and town gas with the exception of liquid gas. Resistance to weather, ageing and ozone. Temperature range -20°C up to +90°C, temporarily up to 100°C, electrically conductive.

Type 50 yellow LT

Like type 50 yellow the media and liquid gas is in accordance with DIN EN 589. For tank vehicles and filling stations. Temperature range -40 up to +90°C, temporarily up to 100°C, electrically conductive.

Type 50 yellow St

For oil, fuel, gas, fuel-ethanol mixture and DIN EN-fuel with up to 50% aromatic content. Natural and town gas with the exception of liquid gas. Resistance to weather, ageing and ozone. Temperature range -20°C up to +90°C, temporarily up to 100°C, flame-resistant up to 30 minutes at 800°C, electrically conductive.

Type 50 yellow HNBR

For oil, fuel, gas, fuel-ethanol mixture and DIN EN-fuel with up to 50% aromatic content. Natural and town gas with the exception of liquid gas. Resistance to weather, ageing and ozone. Temperature range -20°C up to +90°C, temporarily up to 100°C. Cooling water with oil emulsive corrosion protection, lube- and hydraulic oil and sea water. Temperature range -35 up to +100°C, temporarily up to 120°C, electrically conductive.

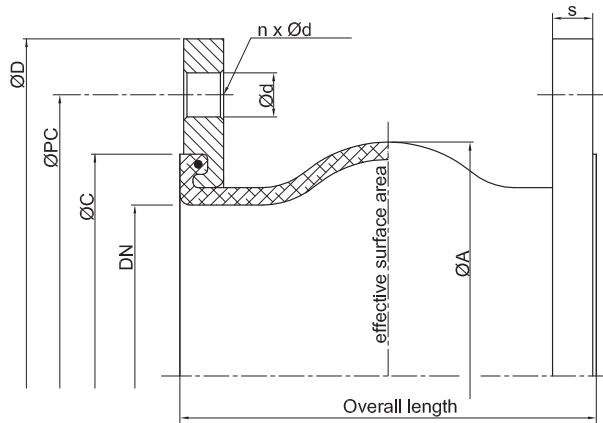

DN	Overall length mm	Bellows		Flange PN 10					ØC mm	For standard types Movement absorption				With steel cord Movement absorption			
		ØA mm	Effective surface cm ²	ØD mm	ØPC mm	Ød mm	n	s mm		axial		lat. +/- mm	∠ ° +/-	axial		lat. +/- mm	∠ ° +/-
										+	-			+	-		
20	130	81	17	105	75	12	4	14	65	30	30	30	30	-	-	-	-
25	130	81	17	115	85	14	4	14	65	30	30	30	30	-	-	-	-
32	130	81	17	140	100	18	4	15	65	30	30	30	30	15	30	10	30
40	130	86	18	150	110	18	4	15	74	30	30	30	30	15	30	10	30
50	130	96	32	165	125	18	4	16	86	30	30	30	30	15	35	10	30
65	130	111	53	185	145	18	4	16	105	30	30	30	30	15	35	10	25
80	130	122	85	200	160	18	8	18	118	30	30	30	30	15	15	10	25
100	130	142	128	220	180	18	8	18	137	30	30	30	20	15	15	10	20
125	130	168	187	250	210	18	8	18	166	30	30	30	20	15	15	10	20
150	130	192	259	285	240	22	8	18	192	30	30	30	20	15	15	10	15
200	130	252	410	340	295	22	8	20	252	30	30	30	12	15	15	10	10
250	130	302	596	395	350	22	12	20	304	30	30	30	12	15	15	10	5
300	130	354	822	445	400	22	12	22	354	30	30	30	12	15	15	10	5
350	200	420	1176	505	460	22	16	24	412	30	50	30	8	-	-	-	-
400	200	480	1547	565	515	26	16	25	470	30	50	30	8	-	-	-	-
500	200	580	2279	670	620	26	20	30	570	30	50	30	8	-	-	-	-
600	200	680	3115	780	725	30	20	30	675	30	50	30	8	-	-	-	-
700	250	800	4342	895	840	30	24	35	780	30	50	30	8	-	-	-	-
800	250	880	5274	1015	950	33	24	40	887	30	50	30	6	-	-	-	-
900	300	1038	7379	1115	1050	33	28	40	985	30	50	30	5	-	-	-	-
1000	300	1138	8894	1230	1160	36	28	40	1085	30	50	30	5	-	-	-	-

Permissible % of indicated movement relative to temperature:
 up to 50°C ~ 100%
 up to 70°C ~ 75%
 up to 90°C ~ 60%

Stiffness rate axial for type 50 (average value by full way)

DN	Overall length mm	0 bar N/mm	2,5 bar N/mm	4 bar N/mm	6 bar N/mm	10 bar N/mm
50	130	25	51	98	134	173
65	130	24	53	100	150	190
80	130	28	58	104	148	185
100	130	35	71	116	206	274
125	130	36	71	137	214	282
150	130	49	102	189	293	390
200	130	100	180	365	568	735
250	130	105	207	388	609	778
300	130	123	248	448	658	883
350	200	105	177	349	567	753
400	200	154	261	516	535	1090
450	250	167	320	581	903	1162
500	200	196	376	686	1060	1364
600	200	208	292	692	1123	1441
700	250	140	198	521	714	954
800	250	180	270	594	975	1258
900	300	200	380	690	1080	1395
1000	300	225	420	742	1248	1568

Stiffness rate lateral for type 50 (average value by full way)

DN	Overall length mm	0 bar N/mm	2,5 bar N/mm	4 bar N/mm	6 bar N/mm	10 bar N/mm
50	130	50	65	80	105	145
65	130	40	78	115	150	165
80	130	35	74	136	155	173
100	130	55	88	143	168	192
125	130	100	200	261	293	383
150	130	120	260	309	366	466
200	130	323	723	836	949	1219
250	130	379	806	1022	1173	1479
300	130	392	837	1068	1216	1542
350	200	305	610	762	875	1098
400	200	338	642	817	946	1199
450	250	342	639	821	971	1200
500	200	426	818	1048	1204	1495
600	200	456	834	1062	1295	1586
700	250	516	939	1191	1449	1775
800	250	558	960	1055	1557	1758
900	300	800	1480	1984	2248	2560
1000	300	960	1824	2361	2736	2976

Attention: Variations in stiffness rate is possible by material reinforcing or production process change with +/-25%.

Tie bar (Standard designs B and C):

Since the rubber bellow is a soft flexible component, under pressure the compensator will always try to move in the axial direction because of its reaction force (bellow cross section area x working pressure).

It must be ensured by constructive measures on the piping (roller bearing, restraining or anchor points) or tie bars directly on the compensator that any over-extension of the bellow is avoided. See tie bar range on pages 50 and 51.

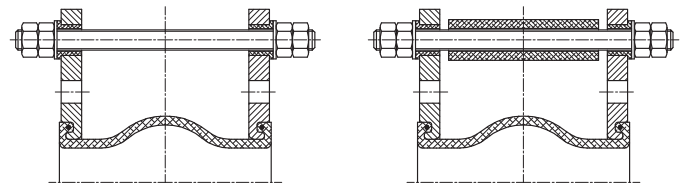

Design B

Design C

Vacuum supporting ring in 1.4571

DN	Art-No.
350	2150315235
400	2150335240
500	2150315250
600	2150315260
700	2150315270
800	2150315280
900	2150315290
1000	2150315310

Flange shapes for tie bars as per designs B and C

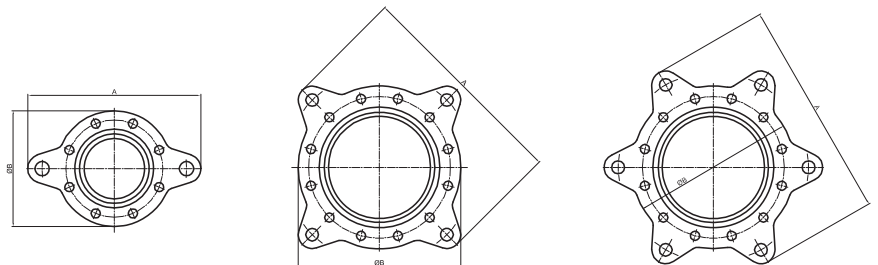

DN 25 - 200

DN 250 - 900 (1000)

DN 1000

Vacuum supporting ring:

WILLBRANDT type 50 compensators are vacuum-resistant. To prevent the compensator bellow being drawn together by suction at negative pressure, the insertion of a vacuum supporting ring is necessary for a suction value above 2 m (0.8 bar abs., 20% negative pressure).

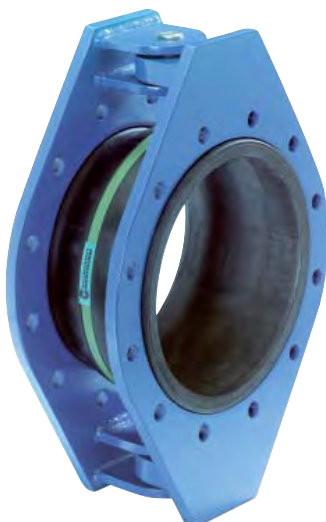

Application example for a gimbal flange design for joint pipe angulation DN 300.

DN	Art-No.
50	2150315150
65	2150305180
80	2150305180
100	2150305210
125	2151305212
150	2150305215
200	2151305220
250	2151305225
300	2151305230

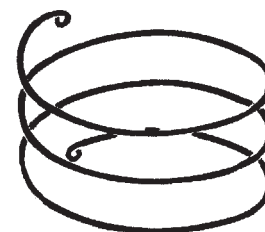

Note:

For aggressive media, see resistance table.
The bellow must not be painted or insulated.
Further installation information is provided in the Annex.

Accessories:

Tie bar/Restrains	See page 50
Deflector sleeve	See page 52
Flameproof protection cover	See page 52
Earth cover	See page 53

Type 50 PTFE chemical design

Type 50 in a special design has a PTFE foil liner for effective resistance against aggressive chemicals.

The PTFE liner is suitable for all commonly used liquids; attention should be paid to heat resistance. The compensator should only be used in higher pressure ranges (up to max. 6 bar); not safe for vacuums.

A special PTFE supporting ring is available for vacuums, but only for DN 65-300.

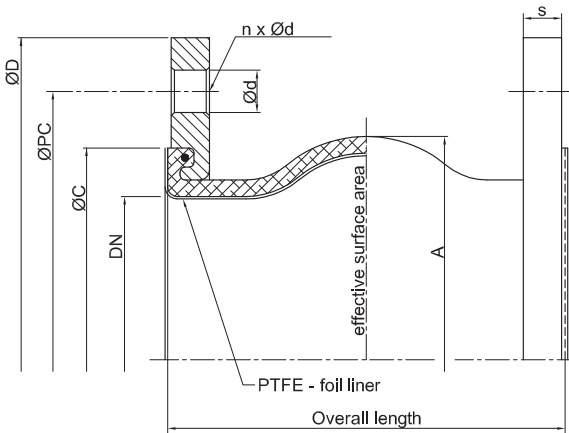

DN	Overall length mm	Bellows		Flange PN 10					Movement absorption axial / lateral				ØC mm
		AØ mm	Eff. surface cm ²	ØD mm	ØPC mm	Ød mm	n	S mm	+ mm	- mm	+/- mm	∠° +/-	
25	130	81	17	115	85	14	4	14	15	15	15	15	65
32	130	81	17	140	100	14	4	15	15	15	15	15	65
40	130	86	18	150	110	18	4	15	15	15	15	15	74
50	130	96	32	165	125	18	4	16	15	15	15	15	86
65	130	111	53	185	145	18	4	16	15	15	15	15	105
80	130	122	85	200	160	18	8	18	15	15	15	15	118
100	130	142	128	220	180	18	8	18	15	15	15	10	137
125	130	168	187	250	210	18	8	18	15	15	15	10	166
150	130	192	259	285	240	22	8	20	15	15	15	10	192
200	130	252	410	340	295	22	8	20	15	15	15	6	252
250	130	302	596	395	350	22	12	20	15	15	15	6	304
300	130	354	822	445	400	22	12	20	15	15	15	6	354
350	200	420	1176	505	460	22	16	24	15	15	15	4	412
400	200	480	1547	565	515	26	16	25	15	15	15	4	470
500	200	580	2279	670	620	26	20	30	15	15	15	4	570
600	200	680	3115	780	725	30	20	30	15	15	15	4	675
800	250	880	4342	1015	950	33	24	40	15	15	15	3	887
900	300	1038	7379	1115	1050	33	28	40	15	15	15	2,5	985
1000	300	1138	8894	1230	1160	36	28	40	15	15	15	2,5	1085

WILLBRANDT Rubber Compensator Type 51 lilac

Type 51 lilac is a special type similar to the 50 series and is manufactured by a special process.

Suitable for chemical plants, particularly for higher thermal duty up to about 150°C.

The highest permissible duty depends on temperature, pressure, movement and life expectancy.

Note:

The bellow must not be painted or insulated.



Bellow colour code	Bellow design			Permissible working data		
	Core (inner)	Reinf. material	Cover (outer)	bar °C	bar °C	bar °C
lilac/red	FPM	Aramide	EPDM	25 50	16 120	4 150
lilac	FPM	Aramide	CR	25 50	16 100	6 120

Burst pressure > 50 bar
 DN 20 - DN 50 suitable for vacuum without supporting ring.
 Suitable for vacuum up to 0.8 bar abs., without supporting ring (2 m suction).
 Suitable for vacuum up to 0 bar abs., with supporting ring (10 m suction).

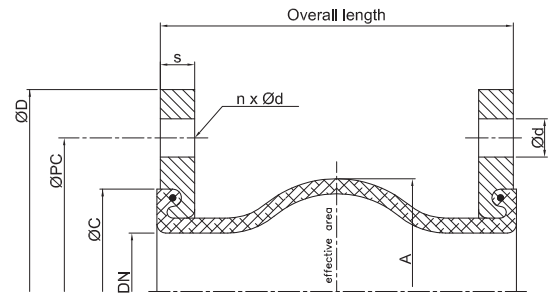

DN	Overall length mm	Bellow		Flange PN 10					Movement absorption				ØC mm
		ØA mm	Eff. surface cm²	ØD mm	ØPC mm	Ød mm	n	S mm	axial + mm	- mm	lat. +/- mm	∠ ° +/-	
32	130	86	27	140	100	18	4	15	10	20	15	20	78
40	130	86	27	150	110	18	4	15	10	20	15	20	78
50	130	96	32	165	125	18	4	16	10	20	15	20	89
65	130	110	53	185	145	18	4	16	10	20	15	20	104
80	130	122	85	200	160	18	8	18	15	20	15	20	119
100	130	142	128	220	180	18	8	16	15	20	15	20	142
125	130	170	187	250	210	18	8	18	15	20	15	20	169
150	130	196	259	285	240	23	8	18	15	20	15	20	195
200	130	256	409	340	295	23	8	20	15	20	15	15	245
250	130	306	599	395	350	23	12	20	15	20	15	10	295
300	130	353	822	445	400	23	12	22	15	20	15	10	348
350	200	442	1176	505	460	22	16	24	15	20	15	10	398
400	200	495	1547	565	515	26	16	25	20	25	20	8	450
500	250	595	2279	670	620	26	20	30	20	25	20	6	563
600	250	695	3115	780	725	30	20	30	20	25	20	6	673
700	250	800	4342	895	840	30	24	30	30	30	30	6	780
800	250	880	5274	1015	950	33	24	30	30	30	30	5	887
900	300	1038	7379	1115	1050	33	28	30	30	30	30	4	985
1000	300	1138	8894	1230	1160	36	28	30	30	30	30	4	1085

WILLBRANDT Rubber Compensator Type 53

Type 53 is a low corrugated bellow compensator with good sound insulating characteristics. It is characterized by a very high expansion capability in all three planes.

Design:

Low corrugated rubber bellow with reinforcing inserts and integral sealing bead (therefore - self-sealing without additional gaskets) for accommodating the steel-backed swivel flange with solid ring support.

The flanges are provided with through holes (PN 6, PN 10, PN 16, ASA150 lbs, etc.).

All steel parts in S 235 JRG2 (RSt 37-2) are zinc plated and passivated.



Details for type 53

Bellow colour code	Core (inner)	Reinforcing material	Cover (outer)	Permissible operating data						Hardness shore A
				bar	°C	bar	°C	bar	°C	
red/blue	IIR-D	Aramide	EPDM	25	80	16	120	10	130	60
yellow/blue	NBR	Aramide	CR	25	50	16	90	10	120	65
green/blue	CSM	Aramide	CR	25	50	16	90	10	120	65

Suitable for vacuum up to 0.8 bar abs., without supporting ring.
 Suitable for vacuum up to 0 bar abs., with supporting ring.
 DN 20 - DN 50 suitable for vacuum without supporting ring.

Special designs:

With tie-rods design B as axial stroke limitation and for absorption of the reaction forces. With tie-rods design C as axial stroke - and thrust limitation, tie-rods supported in rubber bushes (pages 50 and 51).

Design A

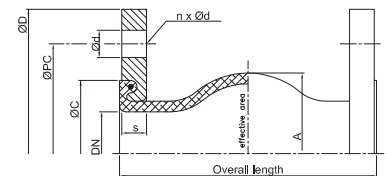

DN	Bellow		Flange PN 10					Movement absorption				ØC
	Overall length mm	ØA mm	ØD mm	ØPC mm	Ød mm	n	s mm	ax + mm	ax - mm	lat ± mm	∠ ± °	
32	130	81	140	100	18	4	15	10	20	15	20	65
40	130	86	150	110	18	4	15	10	20	15	20	74
50	130	96	165	125	18	4	15	10	20	15	20	86
65	130	110	185	145	18	4	15	10	20	15	20	105
80	130	122	200	160	18	8	15	15	20	15	20	118
100	130	142	220	180	18	8	15	15	20	15	20	137
125	130	170	250	210	18	8	18	15	20	15	20	166
150	130	196	285	240	23	8	18	15	20	15	20	192
200	130	256	340	295	23	8	20	15	20	15	15	252
250	130	306	395	350	23	12	20	15	20	15	10	304
300	130	356	445	400	23	12	22	15	20	15	10	354
350	200	442	505	460	22	16	24	15	20	15	10	398
400	200	495	565	515	26	16	25	20	25	20	8	450
500	250	595	670	620	26	20	30	20	25	20	6	563
600	250	695	780	725	30	20	30	20	25	20	6	673

WILLBRANDT Rubber Compensator Type 54 yellow

Type 54 yellow is a low corrugated bellow compensator with good sound insulating characteristics. It is characterized by a very high expansion capability in all three planes.

Design:

Low corrugated rubber bellow with reinforcing inserts and integral sealing bead (therefore - self-sealing without additional gasket) for accommodating steel-backed swivel flanges with solid ring support. The flanges SAE 3000 are provided with through holes.

All steel parts in S235JRG2 (R St 37-2) are zinc-plated and passivated.

Note:

The flanges are also available in other standards, e.g. DIN PN 6, 10, 16 or ASA150 lb.



Details for type 54 yellow

Bellow colour code	Core (inner)	Reinforcing material	Cover (outer)	Permissible operating data			Electrical resistance [Ohm cm]	Hardness shore A
				bar °C	bar °C	bar °C		
yellow	NBR	Nylon	CR	10 50		10 80	5*10 ⁴	60

Suitable for vacuum up to 0.8 bar abs., without supporting ring.
Suitable for vacuum up to 0 bar abs., with supporting ring.

DN	Bellow		Flange SAE 300							Movement absorption				ØC mm
	Overall length mm	Ødi mm	A mm	B mm	D mm	E mm	Ød mm	n	s mm	ax + mm	ax - mm	lat ± mm	∠ ± °	
25/1"	65	24	70	55	52.4	26.2	11	4	11	10	20	10	7.5	46
32/1 1/4"	65	32	80	70	58.7	30.2	13	4	11	10	20	10	7.5	53
40/1 1/2"	100	40	90	80	70.0	35.7	13	4	13	10	20	10	10.0	64
50/2"	100	50	100	90	77.8	42.9	13	4	13	10	20	10	10.0	73
65/2 1/2"	100	65	115	105	89.0	50.8	13	4	14	10	20	10	10.0	89
80/3"	100	80	132	120	106.4	62.0	17	4	14	10	20	10	10.0	102
90/3 1/2"	100	80	146	130	120.6	70.0	17	4	14	10	20	10	10.0	102
100/4"	100	100	156	140	130.2	77.8	17	4	16	10	20	10	10.0	130
125/5"	130	121	184	165	152.4	92.0	17	4	16	10	20	10	25.0	166

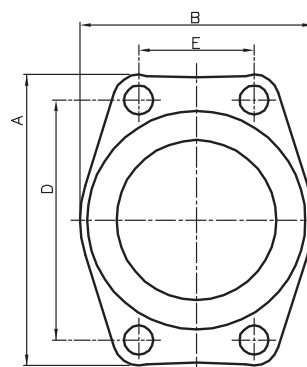
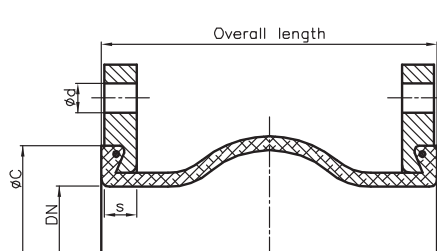

WILLBRANDT Rubber Compensator Type 55

Type 55 is a low corrugated bellow compensator with good sound insulating characteristics (structure- and liquid-borne noise). It is characterized by a high expansion absorption capability, in particular angular expansion.

Design:

Low corrugated rubber bellow with reinforcing inserts and integral sealing beads (therefore self-sealing without additional gaskets) for accommodating swivel flanges. The flanges are provided with through holes.



Details for DN 20 - DN 600

Bellow colour code	Bellow colour ring	Bellows design			Permissible operating data				Short-term C°	Surface resistance Ro [Ohm cm]				
		Core (inner)	Reinforcing material	Cover (outer)	°C	bar	°C	bar			°C	bar	°C	bar
rot Sp	rot-rot	EPDM	Aramide	EPDM	-40	10	70	16	100	10	130	8	150	3 x 10 ³
rot	rot	IIR	Nylon cord	EPDM	-40	10	50	16	70	12	100	10	120	7 x 10 ⁶
gelb	gelb	NBR	Nylon cord	CR	-20	10	50	16	70	12	90	10	100	2 x 10 ²
grün	grün	CSM	Nylon cord	CSM	-20	10	50	16	70	12	100	10	110	3 x 10 ¹¹
gelb St	gelb-gelb	NBR	Nylon cord	EPDM	-20	10	60	16	90	10	100	10	100	7 x 10 ⁸

Burst pressure > 50 bar

Suitable for vacuum up to 0.8 bar abs., without supporting ring.

Suitable for vacuum up to 0 bar abs., with supporting ring.

DN 20 - DN 50 suitable for vacuum without supporting ring.

Burst pressure DN 450 - 1000 > 30 bar

Burst pressure DN 32 - 400 > 50 bar

Details for DN 700 - DN 1000

Bellow colour code	Bellow colour ring	Bellows design			Permissible operating data				Short-term C°	Surface resistance Ro [Ohm cm]				
		Core (inner)	Reinforcing material	Cover (outer)	°C	bar	°C	bar			°C	bar	°C	bar
rot Sp	rot-rot	EPDM	Aramide	EPDM	-40	8	70	10	100	7,5	130	6	150	3 x 10 ³
rot	rot	IIR	Nylon cord	EPDM	-40	8	50	10	70	8	100	6	120	7 x 10 ⁶
gelb	gelb	NBR	Nylon cord	CR	-20	8	50	10	70	8	90	6	100	2 x 10 ²
grün	grün	CSM	Nylon cord	CSM	-20	8	50	10	70	8	100	6	110	3 x 10 ¹¹

Burst pressure > 50 bar

Suitable for vacuum up to 0.8 bar abs., without supporting ring.

Suitable for vacuum up to 0 bar abs., with supporting ring.

Burst pressure DN 450 - 1000 > 30 bar

Burst pressure DN 32 - 400 > 50 bar

Flange: (Design A)

Swivel flanges both sides (design A) with integral rubber profile, so that additional gaskets are not required (self-sealing).

The flanges are drilled to DIN PN 10 as standard. Other specifications in accordance with DIN, ASA, BS. Special flanges are also available.

Flange material:

Standard S 235 JRG2 (RSt 37-2) zinc-plated and yellow passivated. Other materials are available on request (flanges up to DN 200 are partly provided with forged collars towards the bellow side.)

Note:

For aggressive media, see resistance table. The bellow must not be painted or insulated. Further installation information, see Annex.

Vacuum supporting rings:

WILLBRANDT compensators type 55 are not vacuum-resistant. To prevent the compensator bellow being drawn together by suction at negative pressure, the insertion of a vacuum supporting spiral (up to DN 300) alternatively a vacuum supporting ring (from DN 350) is necessary for a suction value above 2 m (0.8 bar abs., 20% negative pressure).

Type 50 red Sp

For heating systems according to DIN 4809, with corrosion-proofed aramidcord inserts for permanent use in hot water and high temperature water, cooling water and hot air. Not suitable for oil emulsive media. Resistance to weather, ageing and ozone. Temperature range -40 up to +130°C, temporarily up to 150°C, surface area electrically conductive.

Type 50 red

For drinking water, hot water with DVGW W270 and ACS approval as well as for sea water, cooling water with chemical additives for water treatment, low concentrated acids and lyes, salt solution. Resistance to weather, ageing and ozone. Temperature range -40 up to +100°C, temporarily up to 120°C, surface area electrically conductive. Not suitable for oil products of all kinds. Cooling water with additives of oil emulsive mixtures.

Type 50 yellow

For oil, fuel, gas, fuel-ethanol mixture and DIN EN-fuel with up to 50% aromatic content. Natural and town gas with the exception of liquid gas. Resistance to weather, ageing and ozone. Temperature range -20°C up to +90°C, temporarily up to 100°C, electrically conductive.

Type 50 yellow St

For oil, fuel, gas, fuel-ethanol mixture and DIN EN-fuel with up to 50% aromatic content. Natural and town gas with the exception of liquid gas. Resistance to weather, ageing and ozone. Temperature range -20°C up to +90°C, temporarily up to 100°C, flame-resistant up to 30 minutes at 800°C, electrically conductive.

Type 50 green

Especially for chemical and aggressive chemical waste water, oil emulsive compressor air, regarding the media it is essential to pay attention to the media resistance table. Resistance to weather, ageing and ozone. Temperature range -20°C up to +100°C, temporarily up to 110°C, electrically insulating.

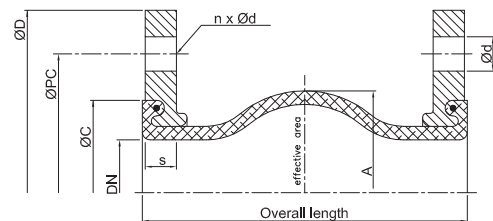

DN	Overall length mm	Bellow		Flange PN 10					Movement absorption				ØC mm
		ØA mm	Eff. surface cm ²	ØD mm	ØPC mm	Ød mm	n	s mm	ax + mm	ax - mm	lat +/- mm	∠ ° +/-	
32	125	81	17	140	100	18	4	15	30	30	30	30	65
40	125	86	18	150	110	18	4	15	30	30	30	30	74
50	125	96	32	165	125	18	4	16	30	30	30	30	86
65	125	110	53	185	145	18	4	16	30	30	30	30	105
80	150	122	85	200	160	18	8	18	30	30	30	30	118
100	150	142	128	220	180	18	8	18	30	30	30	20	137
125	150	170	187	250	210	18	8	18	30	30	30	20	166
150	150	196	259	285	240	22	8	18	30	30	30	20	192
200	175	256	409	340	295	22	8	20	30	30	30	12	245
250	175	306	599	395	350	22	12	20	30	30	30	12	295
300	200	410	822	445	400	22	12	22	30	30	30	12	354
350	200	470	1176	505	460	22	16	24	30	40	30	8	412
400	200	480	1547	565	515	26	16	25	30	50	30	8	470
450	250	545	2279	615	565	26	20	25	20	40	30	6	512
500	250	595	2038	670	620	26	20	30	20	40	30	6	570
600	250	695	3310	780	725	30	20	30	20	40	30	6	675
700	275	800	4342	895	840	30	24	35	30	50	30	8	780
800	250	880	5274	1015	950	33	24	40	30	50	30	6	887
900	300	981	7379	1115	1050	33	28	40	30	50	30	5	985
1000	300	1086	8894	1230	1160	36	28	40	30	50	30	5	1085

Permissible % of indicated movement relative to temperature:

up to 50°C ~ 100%

up to 70°C ~ 75%

up to 90°C ~ 60%



Accessories:

Tie bar/Restrains

Deflector sleeve

Flameproof protection covers

Earth cover

See page 50

See page 52

See page 52

See page 53

WILLBRANDT Rubber Compensator Type 56

Type 56 is a hand-built cylindrical compensator. This process allows the overall length to be varied. It is only designed to compensate for lateral and angular movements. By its corrugated-free design an easy flow is possible with no sediment deposit.

Design:

Cylindrical bellow body with reinforcing inserts and built-in rubber profile for mating with swivel flanges. The compensator is self-sealing, additional gaskets are not required.

Application:

Noise and vibration damper, thermal expansion absorption in delivery pipe lines, on containers and pumps for media containing solid material.



Details for type 56

Bellow colour code	Core (inner)	Reinforcing material	Cover (outer)	Permissible operating data				Electrical resistance [Ohm cm]	Hardness shore A
				bar	°C	bar	°C		
red	EPDM	Nyloncord	EPDM	6	20	6	90	7×10^3	60
yellow	NBR	Nyloncord	CR	6	20	6	90	5×10^3	60
green	CSM	Nyloncord	CSM	6	20	6	80	4×10^3	65
white	NBR/white	Nyloncord	CR	6	20	6	80	5×10^3	55
lilac	FPM	Aramide	CR	6	20	4	150		65

Burst pressure > 25 bar

Flange:

Swivel flanges (design A) both sides with integral sealing bead, no additional gaskets required (self-sealing). Flanges are drilled acc. to DIN PN 10 as standard. Other specifications according to DIN, ASA, BS and special flanges are also available.

Flange Material:

Standard S 235 JRG2 (RSt 37-2) zinc plated and yellow passivated. Other materials available on request.

Note:

Applicable only for lateral and angular movement (crease formation). Do not paint or insulate. See installation information.

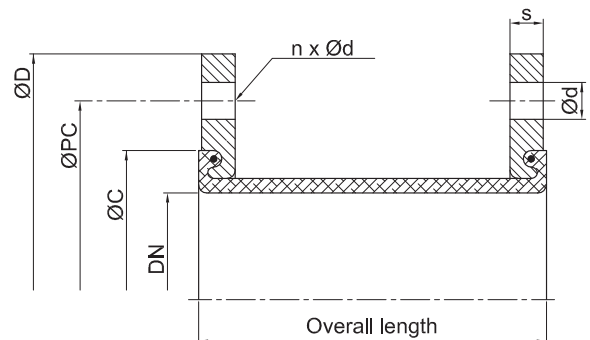

DN	Overall length mm	ØC mm	Flange PN 10					Perm. pressure bar	Δ lat ± mm	Weight length 200 mm kg
			ØD mm	ØPC mm	Ød mm	n	s mm			
40	100 - 1000	78	150	110	18	4	15	6	25	3.6
50	100 - 1000	88	165	125	18	4	15	6	25	4.5
65	100 - 1000	104	185	145	18	4	15	6	20	4.9
80	100 - 1000	119	200	160	18	8	15	6	20	6.0
100	100 - 1000	142	220	180	18	8	15	6	20	7.3
125	100 - 1000	169	250	210	18	8	15	6	20	8.1
150	100 - 1000	195	285	240	22	8	20	6	20	12.5
200	100 - 1000	245	340	295	22	8	20	6	15	16.8
250	100 - 1000	295	395	350	22	12	20	6	15	20.4
300	100 - 1000	348	445	400	22	12	20	6	15	25.2

WILLBRANDT Rubber Compensator Type 57

Type 57 is a conical compensator produced by hand winding. Its overall length can not be varied. We have an extensive mould form package which is available on request. Due to its configuration, type 57 expansion compensation is only possible in the lateral and angular plane.

Design:

Conical bellow body with reinforcing inserts and integral rubber profiles for mating with swivel flanges. The compensator is self-sealing, additional gaskets are not required.

Application:

Noise and vibration damper for use in delivery pipe lines, containers, building outlets and pumps, and wherever a connection bridging piece allowing smooth free flow is required owing to the composition of the medium.



Details for type 57

Bellow colour code	Core (inner)	Reinforcing material	Cover (outer)	Permissible operating data				Electrical resistance [Ohm cm]	Hardness shore A
				bar	°C	bar	°C		
red	EPDM	Nylon cord	EPDM	6	20	6	90	7×10^3	60
yellow	NBR	Nylon cord	CR	6	20	6	90	5×10^3	60
green	CSM	Nylon cord	CSM	6	20	6	80	4×10^{10}	65
white	NBR/white	Nylon cord	CR	6	20	6	80	5×10^3	65
lilac	FPM	Kevlar	CR	6	20	4	150		65

Burst pressure > 24 bar

Flanges:

Swivel flanges both sides (Design A) with integral rubber profile, no additional gaskets required (self-sealing).

The flanges are drilled according to DIN PN 10 as standard. Other specifications according to DIN, ASA, BS and special flanges are also available.

Flange Material:

Standard S 235 JRG2 (RSt 37-2), zinc plated and yellow passivated. Other materials available on request.

Tie bar/Restraints:

It is recommended that these compensator elements be installed with internal bracing. Due to the build up of pressure, elastic deformation occurs which can distend the conical bellow body. This causes the compensator to either compress or high tensile loads to be exerted on the connecting parts.

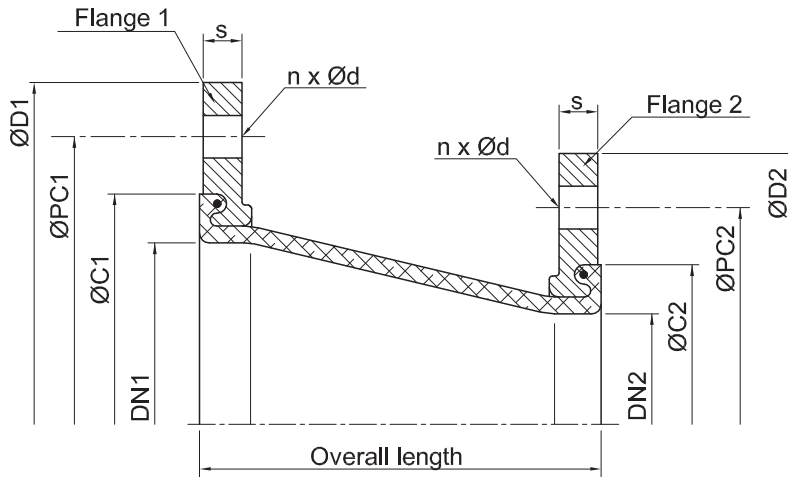

DN ₁	DN ₂	Overall length mm	ØC1 mm	Flange ₁			ØC2 mm	Flange ₂			s mm	Perm. pressure bar	lat ± mm
				ØD1 mm	ØPC1 mm	n x Ød		ØD2 mm	ØPC2 mm	n x Ød			
40	25	250	78	150	110	4 x 18	63	115	85	4 x 18	15	6	30
40	32	250	78	150	110	4 x 18	78	140	100	4 x 18	15	6	30
50	32	250	88	165	125	4 x 18	78	140	100	4 x 18	15	6	30
50	40	250	88	165	125	4 x 18	78	150	110	4 x 18	15	6	30
65	40	250	104	185	145	4 x 18	78	150	110	4 x 18	15	6	30
65	50	250	104	185	145	4 x 18	88	165	125	4 x 18	15	6	30
80	50	250	119	200	160	8 x 18	88	165	125	4 x 18	15	6	30
80	65	250	119	200	160	8 x 18	104	185	145	4 x 18	15	6	30
100	65	250	142	220	180	8 x 18	104	185	145	4 x 18	15	6	30
100	80	250	142	220	180	8 x 18	119	200	160	8 x 18	15	6	30
125	80	250	169	250	210	8 x 18	119	200	160	8 x 18	15	6	30
125	100	250	169	250	210	8 x 18	142	220	180	8 x 18	15	6	30
150	100	250	195	285	240	8 x 22	142	220	180	8 x 18	20	6	30
150	125	250	195	285	240	8 x 22	169	250	210	8 x 18	20	6	30
200	125	300	245	340	295	8 x 22	169	250	210	8 x 18	20	6	30
200	150	300	245	340	295	8 x 22	195	285	240	8 x 22	20	6	30
250	150	300	295	395	350	12 x 22	195	285	240	8 x 22	20	6	30
250	200	300	295	395	350	12 x 22	245	340	295	8 x 22	20	6	30
300	200	300	348	445	400	12 x 22	245	340	295	8 x 22	20	6	30
300	250	300	348	445	400	12 x 22	295	395	350	12 x 22	20	6	30

Special Designs:

Eccentric construction, larger nominal diameters and other sizes available on request.

Note:

For aggressive media, refer to resistance table.
The bellows must not be painted or insulated.

For further installation information, see page 60.

WILLBRANDT Rubber Compensator Type 58

Type 58 is a cylindrical compensator produced by hand winding. The manufacturing process allows production in variable overall lengths. It is only able to compensate for movement in lateral and angular planes due to its design.

Design:

Cylindrical rubber bellow body with reinforcing inserts and integral reinforced solid rubber flanges as well as separate backing support flanges.

Application:

Noise and vibration damper as well as expansion compensator for use in delivery pipe lines, containers, building outlets and pumps, and wherever a connection bridging piece allowing a smooth free flow is required.

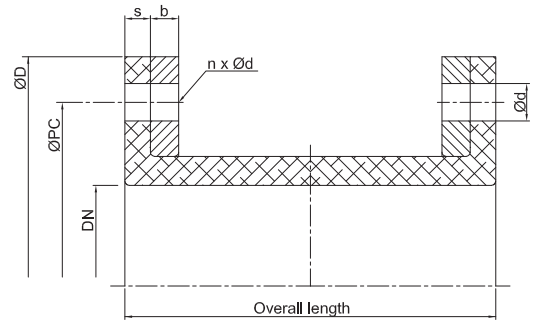

Details for type 58

Bellow colour code	Core (inner)	Reinforcing material	Cover (outer)	Permissible operating data				Electrical resistance [Ohm cm]	Hardness shore A
				bar	°C	bar	°C		
red	EPDM	Nylon cord	EPDM	6	20	6	90	7×10^3	60
yellow/St	NBR	Steel cord	CR	6	20	6	90	1×10^2	60
yellow	NBR	Nylon cord	CR	6	20	6	90	5×10^3	60
green	CSM	Nylon cord	CSM	6	20	6	80	4×10^4	65
white	NBR/white	Nylon cord	CR	6	20	6	80	5×10^3	55
lilac	FPM	Aramide	CR	6	20	4	150		65

Burst pressure > 24 bar

Flange:

Pressure resistant solid rubber flanges with reinforcing inserts and 2-piece backing flanges in S 235 JRG2 (RSt 37-2) drilled according to DIN PN 10. Other materials and hole sizes available on request. The compensator is self-sealing and no additional gaskets are required.

Note:

Only suitable for lateral and angular movements.

Mating flanges must be flat without projections or recesses.

Do not insulate or paint.

See installation information.

DN	Overall length mm	Flange PN 10						Perm. press. bar	lat. +/- mm
		ØD mm	ØPC mm	Ød mm	n	b mm	s mm		
40	150 - 1000	150	110	18	4	8	15	6	15
50	150 - 1000	165	125	18	4	8	15	6	15
65	150 - 1000	185	145	18	4	8	15	6	15
80	150 - 1000	200	160	18	8	8	15	6	15
100	150 - 1000	220	180	18	8	8	15	6	15
125	150 - 1000	250	210	18	8	8	15	6	15
150	150 - 1000	285	240	22	8	8	15	6	15
200	150 - 1000	340	295	22	8	8	20	6	15
250	150 - 1000	395	350	22	12	10	20	6	15
300	150 - 1000	445	400	22	12	10	20	6	15
350	150 - 1000	505	460	22	16	10	20	6	15
400	150 - 1000	565	515	26	16	10	24	6	15
450	150 - 1000	615	565	26	20	10	24	6	15
500	150 - 1000	670	620	26	20	10	24	6	15

WILLBRANDT Rubber Compensator Type 59

Type 59 is a conical rubber bellow produced by hand winding for absorbing lateral and angular movements. Its overall length can only be varied by the production of new moulds. However, an extended range of moulds is available. Only the standard range is shown in this brochure. Please consult us when planning.

Design:

Conical rubber bellow body with reinforcing inserts and integral reinforcing solid rubber flanges and backing support flanges.

Application:

Noise, vibration and underwater sound damper for use in delivery pipelines, containers, pumps and building outlets, and wherever a connection bridging piece allowing a smooth free flow is required.

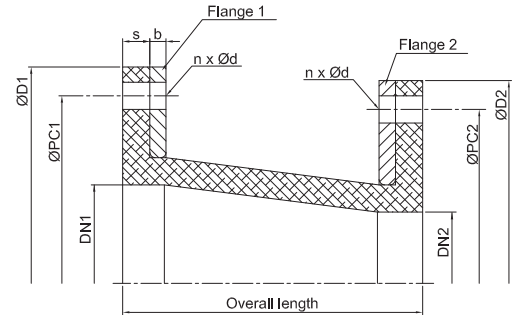

Details for type 59

Bellow colour code	Core (inner)	Reinforcing material	Cover (outer)	Permissible operating data				Electrical resistance [Ohm cm]	Hardness shore A
				bar	°C	bar	°C		
red	EPDM	Nylon cord	EPDM	6	20	6	90	7×10^3	60
yellow/St	NBR	Stahl cord	CR	6	20	6	90	1×10^2	60
yellow	NBR	Nylon cord	CR	6	20	6	90	5×10^3	60
green	CSM	Nylon cord	CSM	6	20	6	80	4×10^4	65
white	NBR/white	Nylon cord	CR	6	20	6	80	5×10^3	55
lilac	FPM	Aramide	CR	6	20	4	150		65

Flanges:

Pressure resistant solid rubber flanges with reinforcing inserts and 1-piece backing flanges in S 235 JRG2 (RSt 37-2) drilled acc. to DIN PN 10. Other materials and hole sizes are available on request. The compensator is self-sealing, no additional gaskets are required.

Special designs:

Eccentric construction, larger nominal diameters and other sizes available on request.

Tie bar/Restraints:

It is recommended that these compensator elements be installed with internal bracing. Due to the build up of pressure, elastic deformation occurs which can distend the conical bellow body. This causes the compensator either to compress or high tensile loads to be exerted on the connecting parts.

Special designs with reinforced bellow parts available (no distension).

Note:

Only suitable for lateral and angular movement. Mating flanges must be smooth without projections or recesses. Do not insulate or paint. See installation information.

DN ₁	DN ₂	Overall length mm	s mm	b mm	Flange ₁			Flange ₂			Perm. press. bar	lat. +/- mm
					ØD ₁ mm	ØPC ₁ mm	n x Ød	ØD ₂ mm	ØPC ₂ mm	n x Ød		
100	65	250	15	8	220	180	8 x 18	185	145	4 x 18	6	30
100	80	250	15	8	220	180	8 x 18	200	160	8 x 18	6	30
125	80	250	15	8	250	210	8 x 18	200	160	8 x 18	6	30
125	100	250	15	8	250	210	8 x 18	220	180	8 x 18	6	30
150	100	250	15	8	285	240	8 x 22	220	180	8 x 18	6	30
150	125	250	15	8	285	240	8 x 22	250	210	8 x 18	6	30
200	125	300	20	8	340	295	8 x 22	250	210	8 x 18	6	30
200	150	300	20	8	340	295	8 x 22	285	240	8 x 22	6	30
250	150	300	20	10	395	350	12 x 22	285	240	8 x 22	6	30
250	200	300	20	10	395	350	12 x 22	340	295	8 x 22	6	30
300	200	300	20	10	445	400	12 x 22	340	295	8 x 22	6	30
300	250	300	20	10	445	400	12 x 22	395	350	12 - 22	6	30
350	250	300	20	10	505	460	16 x 22	395	350	12 x 22	6	30
350	300	300	20	10	505	460	16 x 22	445	400	12 x 22	6	30
400	300	300	24	10	565	515	16 x 26	445	400	12 x 22	6	30
400	350	300	24	10	565	515	16 x 26	505	460	16 - 22	6	30
450	350	300	24	10	615	565	20 x 26	505	460	16 x 22	6	30
450	400	300	24	10	615	565	20 x 26	565	515	16 x 26	6	30
500	400	300	24	10	670	620	20 x 26	565	515	16 x 26	6	30
500	450	300	24	10	670	620	20 x 26	610	565	20 x 26	6	30

WILLBRANDT Pipe Joint Type 60 - WRG

Type 60 is a rubber metal pipe joint for inhibiting noise and surface vibrations in piping on pumps, machines and apparatus.

TÜV approved for installation in heating systems with 100/110°C and 10/6 bar.

Design:

Cylindrical rubber buffer with vulcanized flange rings for accommodating the flange holes. The rubber metal pipe joint is self-sealing and no additional gaskets are required.

Application:

Building installations, hospitals and schools, in heating systems and in water, hot water systems; also suitable for use weak acids and lyes in industrial plants.

Material:

Rubber parts EPDM without inserts.
Steel flange rings with threaded holes.
Only manufactured in EPDM.



Design PN 6

DN	Overall length	Bellow effec. surface	Flange PN 6				Weight
	mm		cm ²	ØD	ØPC	Ød	
20	70	3	90	65	M10	4	0.7
25	70	5	100	75	M10	4	1.0
32	70	8	120	90	M12	4	1.3
40	70	13	130	100	M12	4	1.6
50	70	20	140	110	M12	4	1.8
65	70	33	160	130	M12	4	2.0
80	70	50	190	150	M16	4	2.9
100	70	79	210	170	M16	4	3.3
125	70	123	240	200	M16	8	4.2
150	70	177	265	225	M16	8	4.9
200*	70	314	320	280	M16	8	-

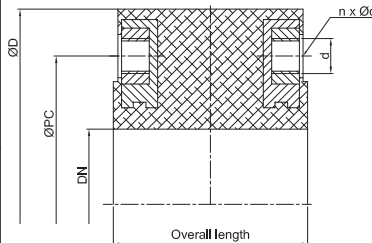

Design PN 10

DN	Overall length	Bellow effec. surface	Flange PN 10				Weight
	mm		cm ²	ØD	ØPC	Ød	
20	70	3	105	75	M12	4	1.0
25	70	5	115	85	M12	4	1.2
32	70	8	140	100	M16	4	1.7
40	70	13	150	110	M16	4	2.1
50	70	20	165	125	M16	4	2.5
65	70	33	185	145	M16	4	2.8
80	70	50	200	160	M16	8	3.3
100	70	79	220	180	M16	8	4.0
125	70	123	250	210	M16	8	4.6
150	70	177	295	240	M20	8	5.5
200	70	314	340	295	M20	8	7.5

*without TÜV

Installation information:

Reliable functioning requires perfect pipeline layout and precisely designed pipe anchors. The rubber metal pipe connections should be installed stress-free. Installation gaps should be 70mm. Tension, torsion or bending loads must be avoided.

Installation should be in an easily accessible location so that maintenance and checks can be carried out. If stress-free installation is not possible or if axial or radial movement is expected, then WILLBRANDT rubber compensators should be used. Additional gaskets are not required since the mating surface is of rubber. Assembly takes place with hexagon head cap screws DIN 933 and plain washers. Tightening torque is 30 Nm. Do not insulate WILLBRANDT pipe joints (heat accumulation!).

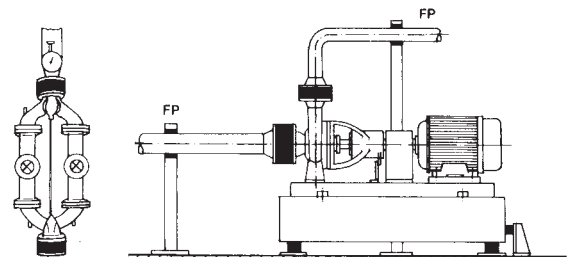

WILLBRANDT Rubber Compensator Type 61

Type 61 is a low corrugated rubber compensator, characterized by its cylindrical end connections, which make quick and easy clamp fitting possible.

Design:

Low corrugated rubber body with reinforcement inserts, cylindrical at both ends for clamp fixing.

Application:

Waste-water piping, motor cooling systems, industrial plants, ventilation plants, purification plants.



Details for type 61

Bellow colour code	Core (inner)	Reinforcing material	Cover (outer)	Permissible operating data				Electrical resistance [Ohm cm]	Hardness shore A
				bar	°C	bar	°C		
red/St red	EPDM	Steel cord	EPDM	6	50	3	100	7×10^3	60
	EPDM	Nylon cord	EPDM	6	50	4	90	7×10^2	60
yellow/St	NBR	Steel cord	CR	6	50	4	90	5×10^4	60
yellow	NBR	Nylon cord	CR	6	50	4	80	5×10^3	60
green	CSM	Nylon cord	CSM	6	50	4	80	4×10^{10}	65
white	NBR/white	Nylon cord	CR	6	50	4	80	5×10^3	60
lilac	FPM	Aramide	EPDM	6	50	2	150		65

Burst pressure >24 bar, vacuum resistant with supporting ring

Note:

Special measurements are possible. Pipeline outside diameter must be clean and smooth (grind down any weld seams). Do not insulate or paint the bellow. Use wide clamps (min. 20x1). Up to 2 bar, one clamp per side can be used. Above 2 bar, we recommend the use of 2 clamps per side.

Movements only for type 61 - A. Type 61 B only for lateral movement +/-10mm.

DN	Ødi mm	Overall length mm	ØA mm	s mm	H mm	B mm	Movement absorption				Weight kg
							ax + mm	ax - mm	lat ± mm	∠ ± °	
50	60.3	250	120	5	97	55	20	25	15	20	0.5
65	76.1	250	135	6	97	55	20	25	15	20	0.6
80	88.9	250	158	6	85	80	20	25	15	20	0.7
100	114.3	250	183	6	85	80	20	25	15	20	0.9
125	139.7	250	208	6	85	80	20	25	15	20	1.1
150	168.3	250	254	7	65	120	20	25	15	15	1.4
175	193.7	250	278	7	65	120	20	25	15	15	1.5
200	219.1	250	304	7	65	120	20	25	15	10	1.7
225	227.0	250	311	7	65	120	20	25	15	10	1.8
250	273.0	250	359	7	65	120	20	25	15	10	2.2
300	323.9	250	408	7	65	120	20	25	15	8	2.6
350	355.6	250	439	7	65	120	20	25	15	8	2.7
400	406.4	250	491	8	60	130	20	25	15	8	3.2
500	508.0	250	594	8	60	130	20	25	15	6	4.0
600	610.0	250	696	8	60	130	20	25	15	6	4.8

Bigger nominal width possible.

WILLBRANDT Draining Hose Type 62

Type 62 has been especially developed for bridge drainage and is able to meet all the demands of this heavy duty application, e.g. large temperature fluctuations, different media, vibration and large extension absorption. To be mentioned in particular is its flexible design with a very low adjustment force.

Design:

Core and covering corrugated throughout with concealed integrated steel wire spiral and corresponding fabric inserts. Spiral-free sleeves at each end for clamp fixing.

Material:

Chloroprene with nylon fabric inserts. Stainless steel or galvanized clamps.



When used in conjunction with SML-pipes the following hose diameters are available:

DN	ØDE mm
50	58
70	78
100	110
125	135
150	160
200	210
250	274
300	326

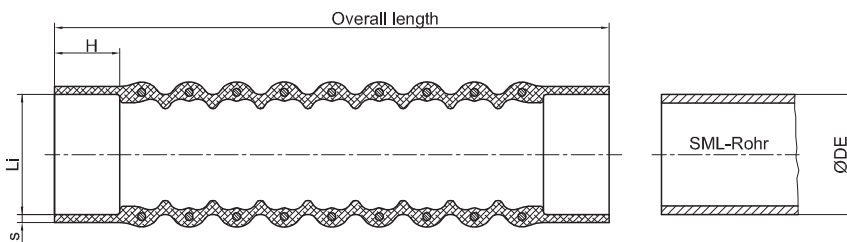

Note:

Check existing temperature during installation and install appropriately pre-tensioned. Do not insulate or paint the hose. When ordering quote the pipe diameter of the sleeve extension. The hose is only suitable for unpressurized operation.

Ø Li mm	H mm	s mm	Length mm
70	50	3	300 - 3000
100	50	3	300 - 3000
125	50	3	300 - 3000
140	50	3	300 - 3000
150	50	3	300 - 3000
200	50	3	300 - 3000
250	50	3	300 - 3000
300	75	3	300 - 3000
350	75	3	300 - 3000
400	75	3	300 - 3000
450	75	3	300 - 3000
500	100	3	300 - 3000
600	100	3	300 - 3000
900	100	3	300 - 3000

Spiral free sleeves at each end, can be extended as required.

Axial compression take-up abt. 30%, lateral extension take-up abt. +/- 15% of flexible length.

WILLBRANDT Rubber Compensator Type 63

Type 63 is a rubber compensator that can be manufactured to specific design dimensions. There are no standard sizes for this particular type. The overall length is variable and depends on the amount of movement to be compensated.

Application:

For air, water and chemical installations as well as internal or external through-wall installation in power stations.

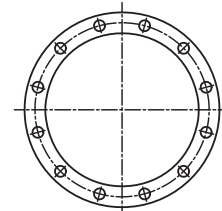
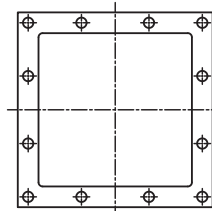
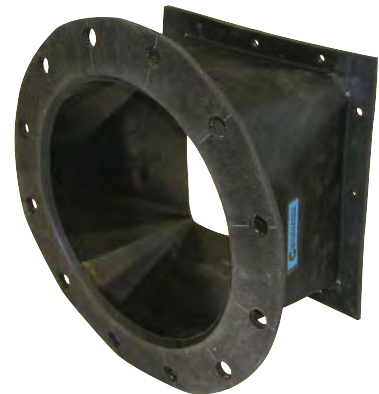

Details for type 63

Bellow colour code	Bellow design			Permissible operating data		
	Core (inner)	Reinforcing material	Cover (outer)	max bar	max ° C	Hardness shore A
red	IIR	Polyester Fabric	IIR	8	120	60
yellow	NBR	Polyester Fabric	NBR	8	120	60
black	CR	Polyester Fabric	CR	8	100	60
green	CSM	Polyester Fabric	CSM	8	100	60
white	SI	Glass Fabric	SI	8	200	50
lilac	FPM	Stainless Steel	FPM	8	180	65

Note:

The permissible pressure stability is largely shape dependent. Available in all shapes: round, rectangular or oval. Operating pressure must be determined depending on shape (round max. 8 bar, rectangular max. 2 bar). Do not paint or insulate! See installation information!



wall sealing with flange



wall sealing with clamps

WILLBRANDT Rubber Compensator Type 64

Type 64 is a compensator that can be manufactured to specific design dimensions. There are no standard dimensions for this particular type. The overall length is variable and depends on the amount of movement to be compensated.

The compensator is manufactured from prefabricated foils and depending on the material is vulcanized or heated in the final form.

Applications:

The diverse materials used make type 64 suitable for a wide range of applications, e.g. problems when handling hot gases and the associated condensate in scrubbing and flue gas systems.

Compared to metal compensators, type 64 in the shortest overall length is capable of absorbing significant axial and lateral expansion and compensate assembly inaccuracies. Noise and vibrations from equipment, e.g. fans, etc., are simultaneously absorbed.



Movement:

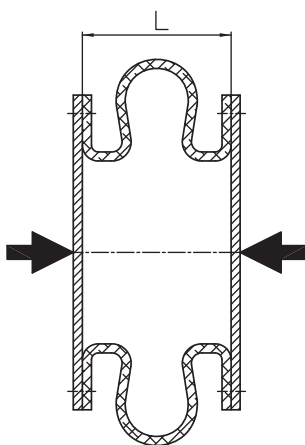

axial -
 $\Delta = \sim 0,3 \times L$

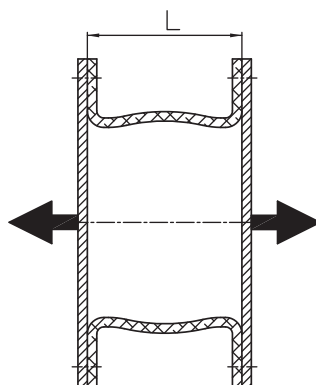

axial -
 $\Delta = \sim 0,05 \times L$

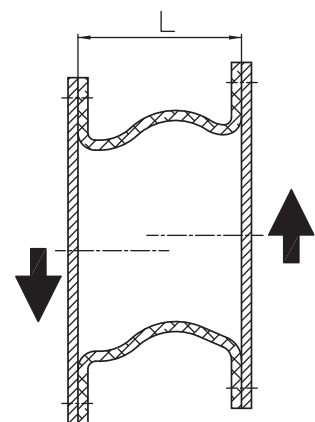

lateral \pm
 $\Delta = \sim 0,1 \times L$

We can improve the movement by corrugation design and choice of material.

Standard designs:

Type 64 is manufactured in two basic designs: Firstly, as a hose-type and a flange-type compensator. Both can be manufactured with flat convex or concave profiles for round and rectangular piping systems in all sizes. The material thickness varies depending on the design between 1mm and 4mm. The connection surfaces in way of the bellow are appropriately reinforced, so that trouble-free connection with clip or flange bolt connection is possible.

It should also be noted, that the compensators with flange design are available pre-shaped up to a diameter of 1200mm; for larger dimensions, these components are supplied flat so that the flanges can be erected during assembly.

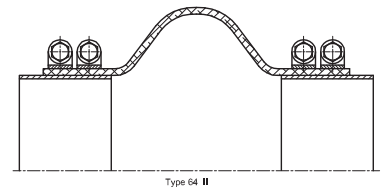
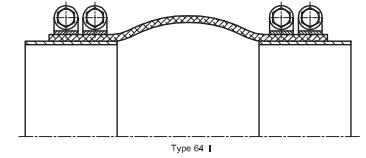
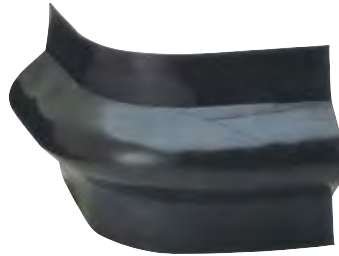

Applications:

Plant construction, power stations, combustion gas desulphurization plants, purification plant, rain water systems, pipe wall penetrations, etc.

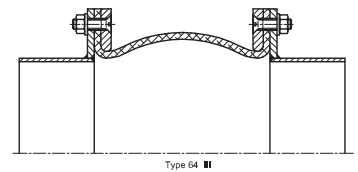
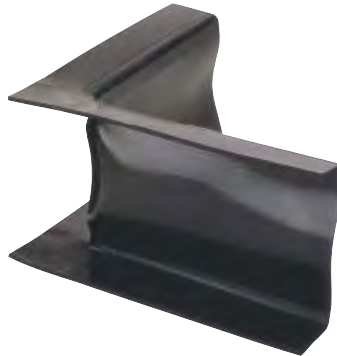

Note:

See installation information.
The compensators should not be painted or insulated as this can cause premature failure of the materials!
In case of enquiries, please specify the particular design and respective hole pattern.

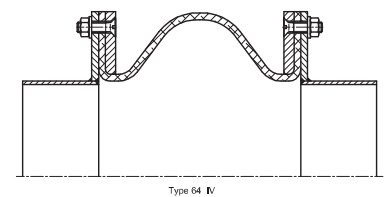
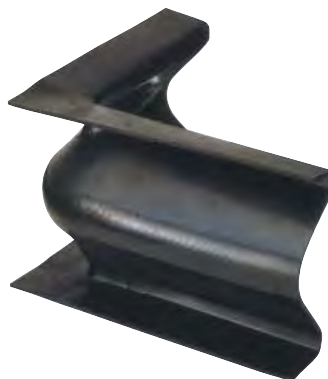

Type 64 data

Bellow colour code	Bellow design			Permissible operating data		Hardness shore A
	Core (inner)	Reinforcing material	Cover (outer)	max. bar	max. °C	
red	EPDM	Nylon cord	EPDM	0.5	120	65
grey	CR	Nylon cord	CR	0.5	100	55
none	FKM	Nylon cord	FKM	0.5	200	70
none	PTFE	-	-	0.3	200	-

WILLBRANDT PTFE Compensator Type 80

Type 80 is a PTFE expansion bellow compensator hot-formed from extruded PTFE tubing under pressure to form continuous corrugations.

Design:

Pure PTFE bellow with external stainless steel supporting rings, PTFE profiles on both sides with steel backing-flange and integral brace.

Application:

Chemical plants, for movement and noise reduction as well as compensation of assembly inaccuracies. Recommended for use in piping of fragile materials, e.g. glass, graphite, enamel. Minimal compensating forces are necessary due to the elasticity of the material.

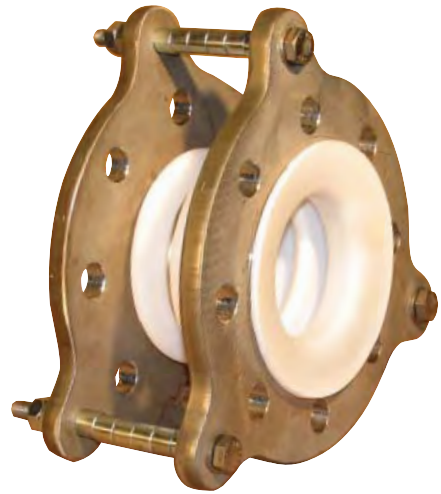

°C Power curve under pressure with 3 waves

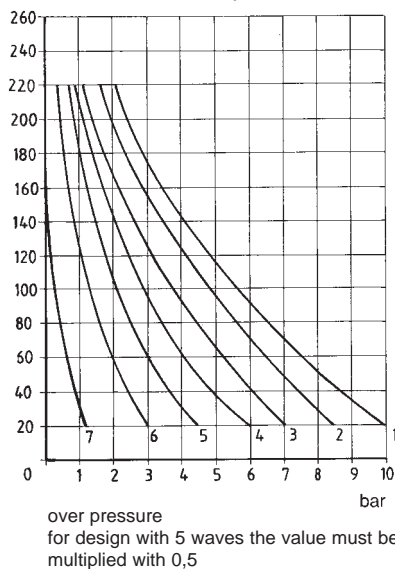

curve	DN
1	25 - 80
2	100 - 150
3	200 - 250
4	300 - 350
5	400 - 450
6	500 - 600
7	700 - 1200

°C Power curve in vacuum with 3 waves

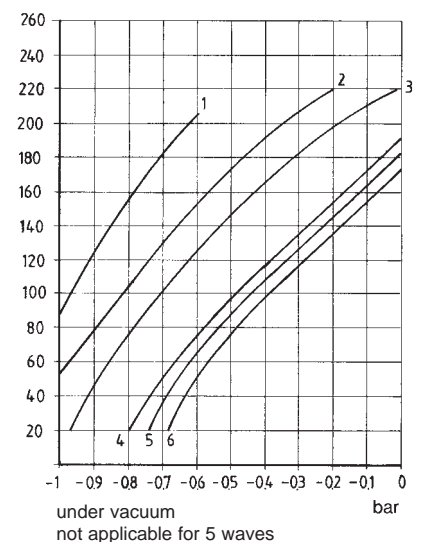

Important installation information:

It is imperative that gaskets are used except in the case of PTFE/PTFE-connections, e.g. PTFE covered IT gaskets (Design 1) or PTFE covered IT gaskets with stainless steel inserts (Design 2) or their equivalent.

Note:

Not suitable for vibrations!
Do not insulate!
See installation information!

Special designs:

For glass tubing.
For total vacuum.
For higher working pressure.
Available on request.

Special construction up to PN 16 possible in 2 - 10 corrugated design (Type 80 HD).

Flanges:

Steel edge flanges with antirust coating on both sides, drilled acc. to DIN PN 10.
Other materials and hole patterns available.



Type 1



Type 2

Movement forces type 80

DN	3 Convolutions		5 Convolutions	
	ax ± N/mm	lat ± N/mm	ax ± N/mm	lat ± N/mm
20	45	20	-	-
25	45	20	40	15
32	50	25	40	20
40	50	28	40	20
50	50	45	40	35
65	40	50	35	40
80	40	60	35	45
100	50	90	35	60
125	60	110	40	80
150	100	150	80	120
200	150	180	100	150
250	150	200	100	170
300	150	200	120	170
350	200	270	160	250
400	200	270	200	230
450	250	290	200	240
500	300	350	250	300
600	300	350	250	300
700	350	410	-	-
800	380	490	-	-
900	400	530	-	-
1000	425	570	-	-
1200	460	620	-	-

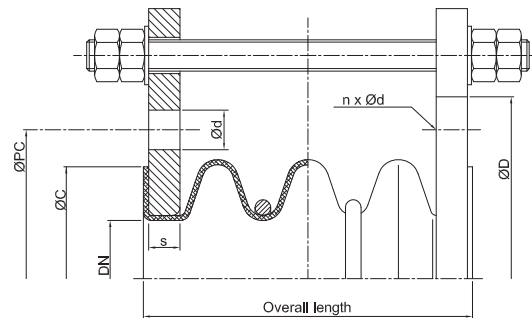
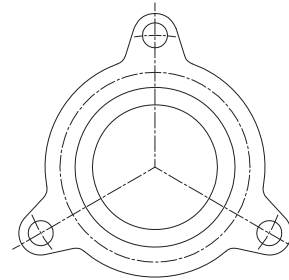

DN	Effec. bellow surface cm ²	Flange						ØC mm	3 Convolutions					5 Convolutions				
		ØD mm	ØPC cm ²	Ød mm	n	s mm	Movement absorption			Weight kg	Movement absorption			Weight kg				
							Overall length mm		axial		lat. +/- mm	length mm	axial		lat. +/- mm			
		+	-	+	-													
20	9	105	75	14	4	12.0	53	50	10	10	8	2.5	-	-	-	-	-	
25	13	115	85	14	4	10.0	62	50	12	12	10	2.5	70	15	15	12	2.8	
32	18	140	100	18	4	12.5	72	50	12	12	12	3.0	75	20	20	18	3.5	
40	25	150	110	18	4	12.5	80	50	12	12	15	4.0	75	20	20	20	4.5	
50	39	165	125	18	4	14.5	98	75	15	15	15	6.0	100	20	20	25	6.5	
65	55	185	145	18	4	18.5	118	75	22	22	17	7.0	100	35	35	30	7.5	
80	90	200	160	18	8	18.5	122	100	25	25	17	8.0	125	40	40	30	9.0	
100	135	220	180	18	8	18.0	148	100	25	25	17	10.0	150	40	40	30	11.0	
125	190	250	210	18	8	20.5	174	125	28	28	18	12.0	175	45	45	32	13.0	
150	295	285	240	22	8	21.0	200	150	28	28	18	15.0	225	45	45	32	17.0	
200	460	340	295	22	8	23.0	256	150	28	28	20	20.0	225	45	45	32	22.0	
250	670	395	350	22	12	27.0	303	150	28	28	10	35.0	225	45	45	15	37.0	
300	940	445	400	22	12	27.0	360	150	30	30	8	48.0	225	50	50	10	50.0	
350	1080	505	460	22	16	27.0	402	150	30	30	6	57.0	225	50	50	8	59.0	
400	1400	565	515	27	16	27.5	453	150	30	30	6	70.0	225	50	50	8	72.0	
450	1800	615	565	27	20	27.0	513	150	30	30	5	78.0	225	50	50	7	80.0	
500	2100	670	620	27	20	29.0	564	150	30	30	5	86.0	225	50	50	7	89.0	
600	3100	780	725	30	20	33.0	658	175	30	30	4	125.0	250	50	50	6	130.0	
700	4415	895	840	30	24	33.0	800	170	35	35	2	128.0						
800	5700	1015	950	33	24	35.0	905	170	35	35	2	130.0						
900	7120	1115	1050	33	28	35.0	1005	170	35	35	2	133.0						
1000	8740	1230	1160	36	28	35.0	1110	170	35	35	2	146.0						
1200	12561	1455	1380	39	32	35.0	1330	170	35	35	2	175.0						

WILLBRANDT PTFE Compensator Type 80 HD

Type 80 is a PTFE expansion bellow compensator hotformed from extruded PTFE tubing under pressure to form continuous convolutions. Available with 2 to 10 convolutions for all nominal widths.

Design:

Pure PTFE bellow with external stainless steel support rings, PTFE profiles on both sides with steel backing flange and integral restraint.

Flange:

Material GGG 40 with rust preventive coating (hole circle drilling partly with threaded holes, for narrow design), standard design PN 10.

Special holes and materials available on request.

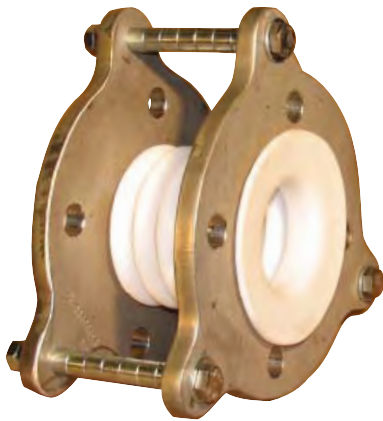

Pressure- and vacuumdiagram with temperature influence

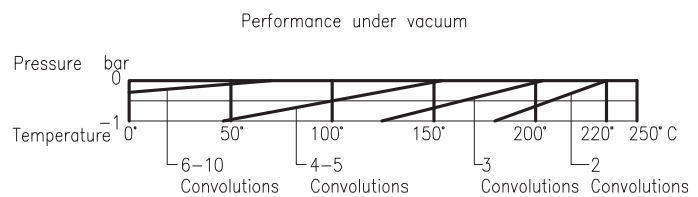
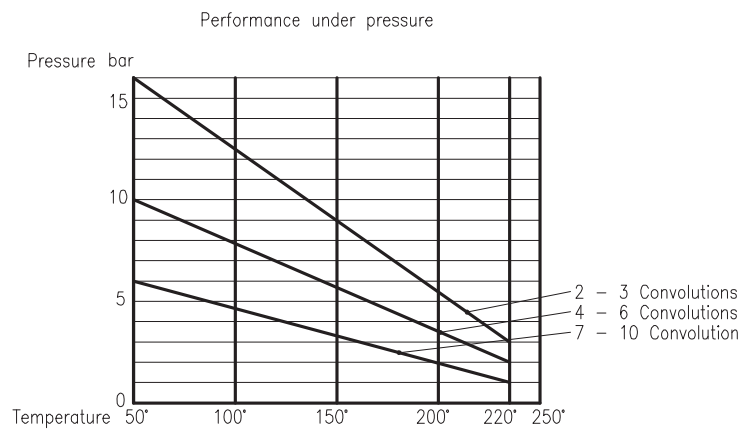

DN	Overall length			Movement absorption with 2 convolutions			Movement absorption with 3 convolutions			Movement absorption per further convolution*		
	2 Conv. mm	3 Conv. mm	+ je Conv.* mm	ax +/- mm	lat +/- mm	ang +/- °	ax +/- mm	lat +/- mm	ang +/- °	ax +/- mm	lat +/- mm	ang +/- °
25	45	55	12	6	4	9	9	6	14	3.0	2.0	4.5
32	55	65	13	6	4	8	9	6	12	3.0	2.0	4.0
40	55	70	15	7	5	8	11	8	12	3.5	2.5	4.0
50	60	70	16	7	5	7	11	8	11	3.5	2.5	3.5
65	60	80	20	8	6	7	12	9	11	4.0	3.0	3.5
80	65	90	24	8	6	7	12	9	11	4.0	3.0	3.5
100	70	95	25	9	6	6	14	9	9	4.5	3.0	3.0
125	75	100	25	9	6	6	14	9	9	4.5	3.0	3.0
150	75	105	25	10	6	5	15	9	8	5.0	3.0	2.5
200	80	110	25	10	7	4	15	11	6	5.0	3.5	2.0
250	90	120	26	11	7	4	17	11	6	5.5	3.5	2.0
300	95	125	26	11	7	3	17	11	5	5.5	3.5	1.5
350	100	125	26	12	7	3	18	11	5	6.0	3.5	1.5
400	100	135	26	12	7	3	18	11	5	6.0	3.5	1.5
500	105	140	26	15	8	3	20	12	5	6.5	4.0	1.5
600	105	140	26	13	8	2	20	12	3	6.5	4.0	1.0

*max. 10 Convolutions
flange picture see page 71.

WILLBRANDT Rubber Compensators Tie Bars / Restraints

Under pressure, rubber compensators develop a reaction force in positive axial direction (effective surface x working pressure) which for unrestrained compensators - Design A - must be absorbed by the nearest anchor points or roller bearings. When used for the absorption of vibrations, lateral and angular expansion as well as noise, it is possible by the arrangement of restraints to create a controlled installation situation (controlled expansion absorption, see installation information).

Our B-M limiter types can be used for all types (except H - only for type 49).

The diagrams show the various types.



Example of the application of a flange design as a universal joint DN 300 (design G)

Flange shapes for tie bars as per designs B-E (10 bar)

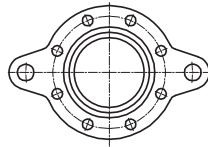

DN 25 - 200

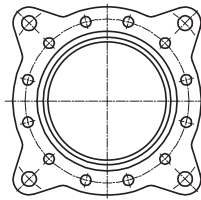

DN 250 - 900 (1000)

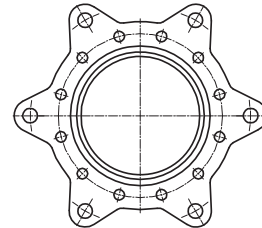

DN 1000

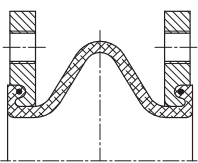

Design A

Rubber compensator without restraint with swivel flanges, suitable for all-round movement absorption.

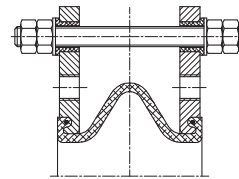
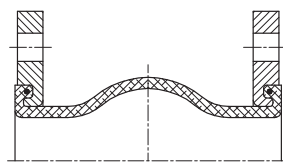

Design B

Rubber compensator with tie bar for the absorption of reaction force. Tie-rods fitted in rubber bushes. Suitable for absorbing noise, vibrations and lateral (radial) movement (+/-10 / - 15 mm).

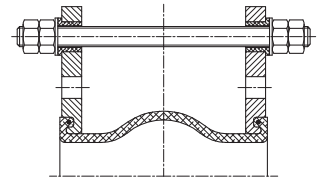

Design C

Rubber compensator with tie bar for absorption of reaction force. Tie-rods fitted in rubber bushes including thrust limiters for bellow retention. Suitable for absorbing noise, vibrations and lateral (radial) movement (+/-10 / - 15 mm).

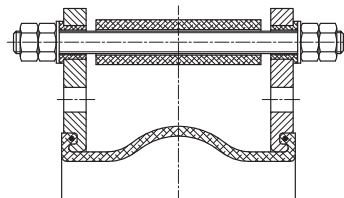
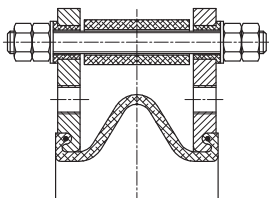

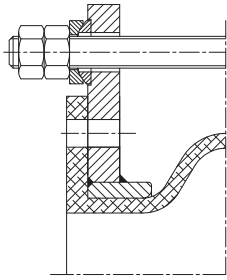

Design E

Rubber compensator with tie bar for absorbing the reaction force. Tie-rods are fitted with c-shaped washer and ball disc. Suitable for lateral movement (radial).

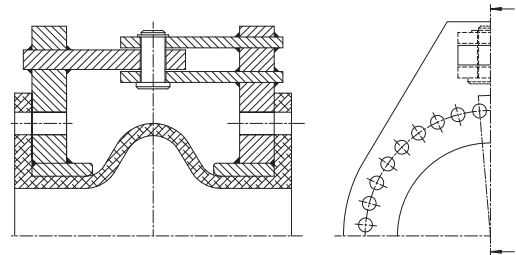

Design F

Rubber compensator with hinged arrangement for absorbing the reaction force. Suitable for angular movement in one plane; two hinged compensators with an intermediate pipe can absorb very large lateral movements (see installation examples).

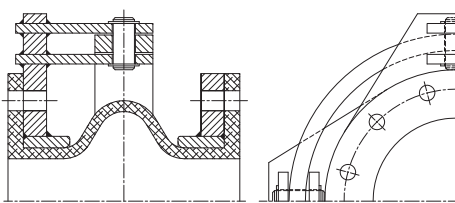

Design G

Rubber compensator with universal restraint for absorbing the reaction force. Suitable for absorbing angular movement in a circular plane. Three universal joints in an angular arrangement can absorb very large axial and lateral movement (see installation examples).

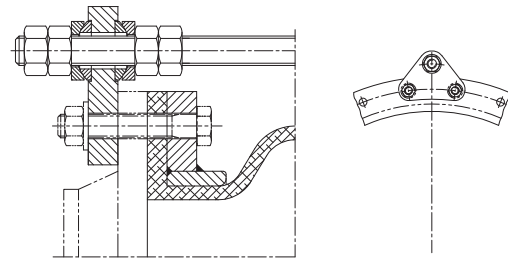

Design L

Rubber compensators with segment restraint supported in spherical discs/conical sockets for absorbing thrust and tensile forces. Suitable for absorbing lateral movement in pressurised and vacuum applications.

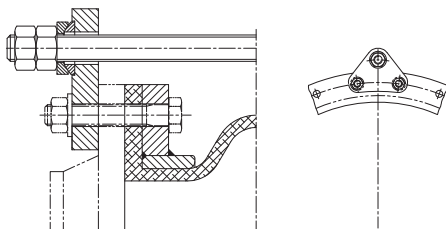

Design K

Rubber compensator with external tie bars fitted with c-shaped washer for absorbing the reaction forces. Suitable for absorbing large lateral (radial) expansion.

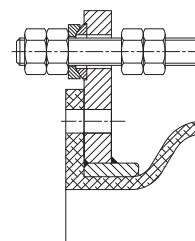

Design H

Rubber compensator with external tie-rod restraint for absorbing the reaction force. External tie-rods are supported in spherical discs and ball cups with internal hexagon nuts for thrust limitation.

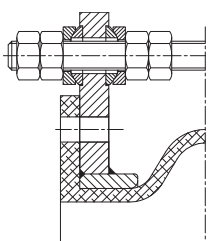

Design M

Rubber compensator with internal restraint and tie rods supported in spherical discs/conical sockets for absorbing thrust and tensile forces. Suitable for absorbing lateral movement in pressurised and vacuum applications.

Note:

In normal cases, the design of the restraints is based on the reaction/friction force. Please contact us should additional pipe forces need to be absorbed!

Special Parts

Flameproof protective covers

Types 40, 49, 50, 55 are available in asbestos-free design approved by the Classification Society.

These accessories protect the rubber compensator against the effects of flames up to 800°C for a period of 30 minutes. WILLBRANDT compensators together with their flameproof protective covers satisfy the requirements of the Classification Society for use on ships, for fire extinguishing piping in operational buildings or in pressure booster plants.

Installation information:

The compensators are installed in the usual manner. The protective covers are fitted after installation and cover both the compensator and adjacent pipe flange. Operation of WILLBRANDT compensators is not hindered as the cover extends to the pipe, the full movement of the compensator can be absorbed. Special cover and restraint sizes are available on request.



Diagram shows open condition.

Deflector sleeve

This should always be used for highly abrasive media or if strong turbulence is to be avoided. The deflector sleeve is made in conical form with edge flange/holed flange, so that the expansion capabilities of the compensator are least affected.

The deflector sleeve length depends on the length of the compensator and the movement to be absorbed (standard value: compensator length - 15 mm corresponds to the deflector sleeve length).

Installation information:

Gaskets must be fitted. Gap between the buildings should be arranged according to the deflector.

Attention:

In the case of axial expansion in excess of -15mm, the mating flange inside diameter must be taken into account and the deflector sleeve diameter checked. With lateral expansion, the deflector sleeve diameter reduces by twice the lateral movement to be absorbed (standard design for lat. +/-5mm).

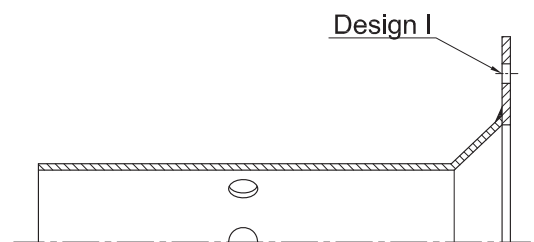

Design I with flange hole pattern

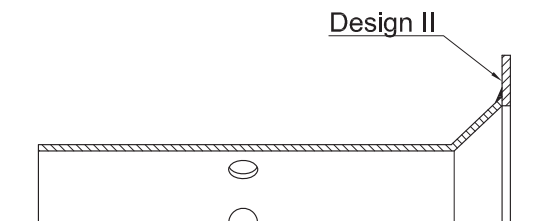

Design II with collar

Special Parts

Earth Cover

Available for all types with or without tie bar.

The earth cover is a two-piece cover, which is especially designed to protect rubber compensators in the earth. It is designed not to limit compensator movement.

Design:

Two-piece cover of S 235 JR G2 (RSt 37-2) or stainless steel. Fixing takes place with clamps which are permanently joined to the halves of the covers.

Note:

Easy installation, due to two-piece design. It must be ensured during installation that downward drainage is possible.

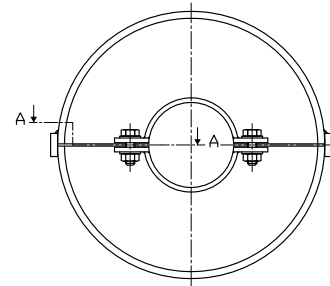
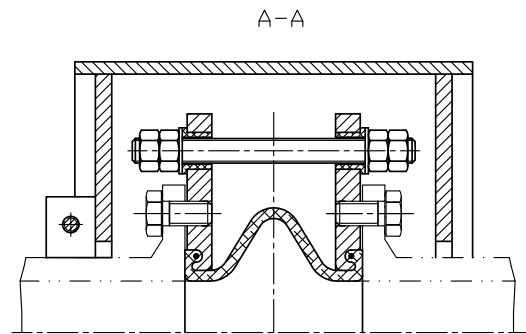

Safety compensator

Available for all types with or without tie bar.

The safety compensator is used for aggressive media for the purpose of leakage monitoring (2-bellow system).

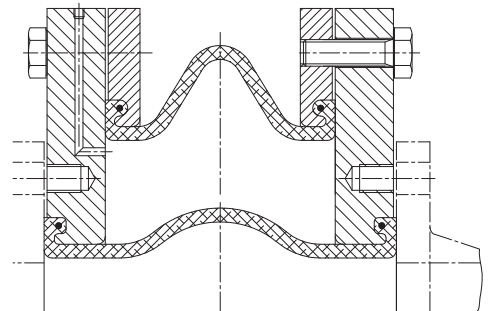

Pressure balanced compensator

Available for all types. The pressure balanced compensator absorbs the reaction forces within the restraint and is suitable for absorbing axial and lateral movement.

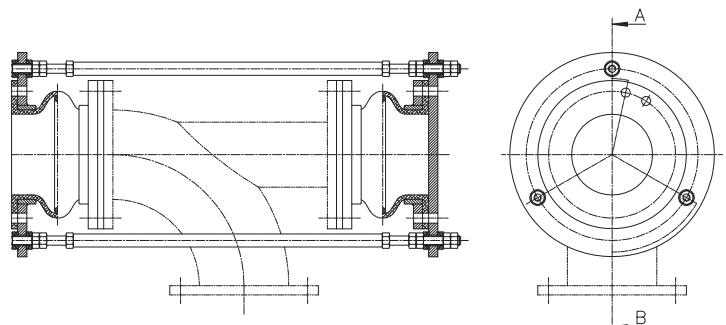

WILLBRANDT Stainless Steel Compensators

Standard range overview

Shown on the following pages are our extensive range of products of which we carry a large selection in stock. These are the types most frequently used in normal practice.

The type of connections illustrated can be varied to suit specific requirements. Alternatively we can supply weld ends, flanges or connecting parts in a special design or request. We can also manufacture compensators in a special design according to individual specifications.

Type	Exhaust expansion joints PN 2.5 multi-ply, DN 40
200	with weld ends
201	with weld ends and internal sleeve
202	with loose flanges
203	with *loose flanges and internal sleeve
204	with fixed flanges
205	with fixed flanges and internal sleeve

Type	Axial expansion joints with 1 layer PN 10/16 DN 15 – DN 250
206	with weld ends (formerly type 200)
207	with weld flanges and internal sleeve (formerly type 200-L)
208	with loose flanges (formerly type 230)
209	with loose flanges and internal sleeve (formerly type 230-L)

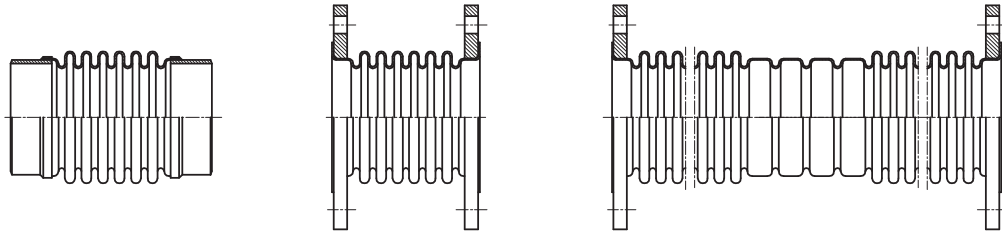

Type	Axial expansion joints - multi - ply PN 10 - PN 25, from DN 40
210	with weld ends
211	with weld ends and internal sleeve
212	with loose flanges
213	with *loose flanges and internal sleeve
214	with fixed flanges
215	with fixed flanges and internal sleeve
216	with welded neck flanges
217	with welded neck flanges and internal sleeve

Type	Lateral expansion joints - multi - ply PN 10 - PN 25, from DN 40
220	with weld flanges
221	with weld flanges and internal sleeve
222	with fixed flanges
223	with fixed flanges and internal sleeve

* On one side with loose flange and on the other side with fixed flange.

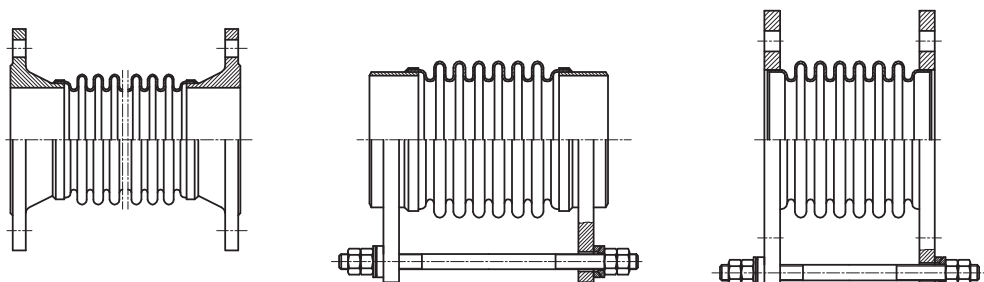

Type Angular expansion joints, onesided movable PN 10 - PN 25, multi-ply from DN 40

- 230** single hinged, with weld ends, movable in one plane
- 231** single hinged, with weld ends and internal sleeve, movable in one plane
- 232** single hinged, with fixed flanges, movable in one plane
- 233** single hinged, with fixed flanges and internal sleeve, movable in one plane

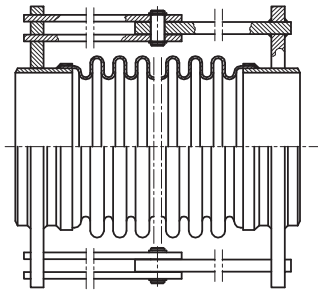

Type Angular expansion joints, movable on all sides PN 10 - PN 25, multi-ply from DN 40

- 234** single gimbal, with weld ends, movable in all directions
- 235** single gimbal
- 236** single gimbal, with fixed flanges, movable in all directions
- 237** single gimbal, with fixed flanges and internal sleeve, movable in all directions

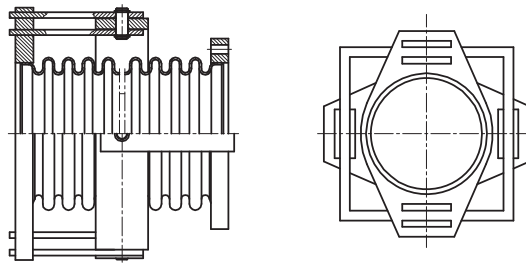

Type Lateral expansion joints as Double Hinge Unit PN 10 – PN 25, multi-ply from DN 40

- 224** with weld ends
- 225** with weld ends and internal sleeve
- 226** with fixed flanges
- 227** with fixed flanges and internal sleeve

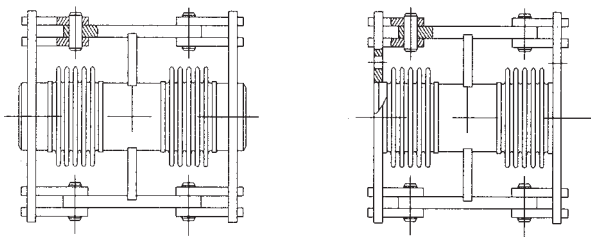

Type District heating expansion joints from DN 40

- 228** One-Step design
- 229** Standard design
 - short length
 - long installation length

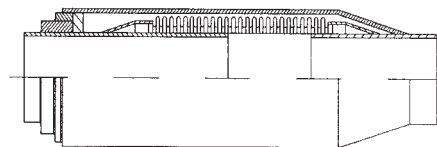

Type Pressure Balanced Bellow from DN 40

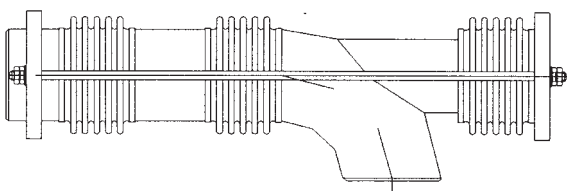

Type Heating compensator DN 15 - DN 50

- 270** both sides with threaded connection

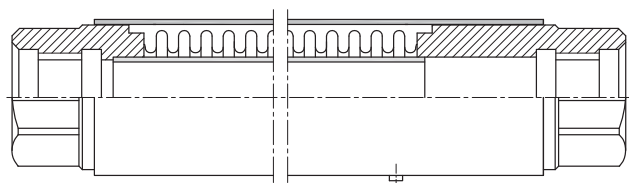

Stainless Steel Hose Type 310/311

Type 310

Stainless steel corrugated hose without braiding

Type 311

Stainless steel corrugated hose with braiding

Design

Parallel corrugated all-metal hose manufactured from butt welded pipe. Available with or without braiding.

Hose materials

Standard: 1.4541/DIN17440

Special material: 1.4571/DIN17440

Braiding

Standard: 1.4301

Also available in 1.4571 or 1.4541 on request.

Other special materials are available for hose and braiding subject to specific order quantities on request.

Temperature

Operating range from -270°C to max. +600°C possible.

Bending radius

Use the following table as a guide.

Distinction must be made between: Minimum bending radius with single bending and normal bending radius for frequent bending.

Material connection

Available are various types of connections that are shown on the following page. These connections are available in diverse materials.

The following table contains selection criteria:

Selection criteria		Material of the connections				
No.	Indication (draft page 54)	Steel	Stainless steel	Brass	Malleable cast iron	Red cast
001	Collar loose flange	X	X			
002	Fixed flange	X	X			
003	Pipe fixed flange	X	X			
004	Pipe collar loose flange	X	X			
005	Flared tube end loose flange	X	X			
006	Tube socket / weld end	X	X	X	X	
007	Conical outside threading	X	X	X	X	X
008	Bushing	X	X	X	X	X
009	Cylindrical outside threading	X	X	X	X	X
010	Hexagonal bushing	X	X	X	X	X
011	Conical screw fitting with outside threading	X	X		X	X
012	Conical screw fitting with inside threading	X	X		X	X
013	Flat sealed screw fitting with outside threading	X	X		X	X
014	Flat sealed screw fitting with inside threading	X	X		X	X
015	Socket union nut	X	X	X	X	X

Further connections on request.

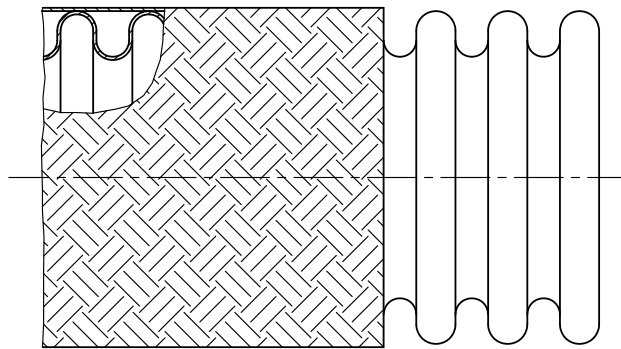

Characteristics

Inch	Inner-Ø	Tolerance (inner)	Type	Outer-Ø	Tolerance (outer)	Pressure	Nominal bend radius	Minimum bend radius	Weight ± 10 %
	mm			mm			mm	Frequently bending	
3/8	10.6	0.3	310	16.1	0.6	5.0	125	35	150
			311	17.5	0.8	75.0	190	35	300
1/2	12.9	0.3	310	19.3	0.6	5.0	140	35	160
			311	20.8	0.8	70.0	210	35	320
5/8	15.7	0.4	310	23.7	0.8	4.0	190	45	250
			311	25.2	1.0	65.0	285	45	500
3/4	19.8	0.4	310	28.8	0.8	3.0	215	55	280
			311	30.3	1.0	50.0	310	55	530
1	25.8	0.4	310	34.5	0.8	3.0	250	70	380
			311	36.0	1.0	40.0	375	70	750
1 1/4	33.0	0.4	310	43.7	0.8	3.0	270	80	420
			311	45.7	1.0	35.0	405	80	950
1 1/2	40.0	0.5	310	52.0	1.0	2.0	320	100	700
			311	54.0	1.2	30.0	480	100	1350
2	51.6	0.5	310	65.5	1.0	1.0	360	130	880
			311	67.5	1.2	25.0	550	130	1600
2 1/2	66.0	0.6	310	85.4	1.2	1.0	450	175	1250
			311	87.9	1.4	20.0	675	175	2600
3	76.6	0.6	310	97.5	1.2	1.0	500	200	1750
			311	100.0	1.4	18.0	750	200	3200
4	103.0	1.0	310	125.0	1.2	1.0	600	250	2100
			311	128.0	1.4	14.0	920	250	4400
5	127.5	1.0	310	151.5	1.2	1.0	750	325	3250
			311	154.5	1.4	12.5	1160	325	5750
6	151.5	1.0	310	177.0	1.2	0.8	850	375	4000
			311	180.0	1.4	10.0	1320	375	6900

Connection options for stainless steel hoses type 310/311

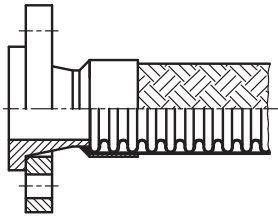

001

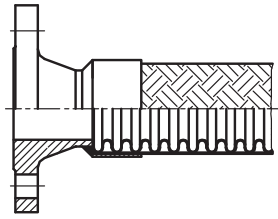

002

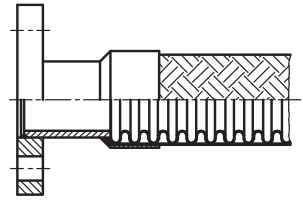

003

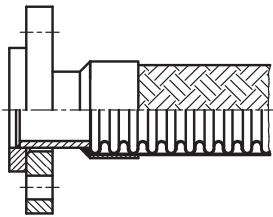

004

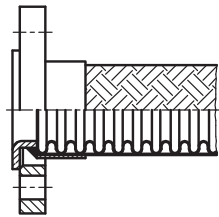

005

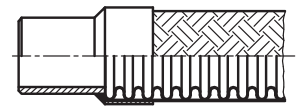

006

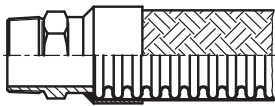

007

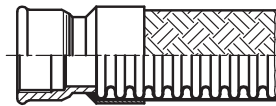

008

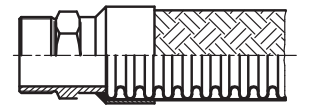

009

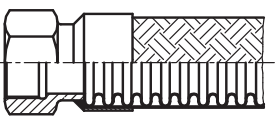

010

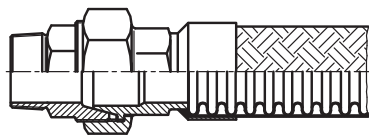

011

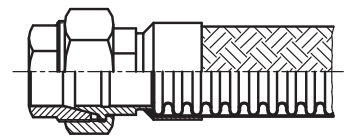

012

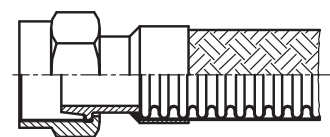
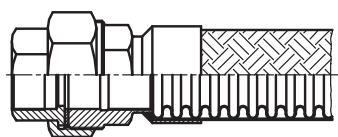
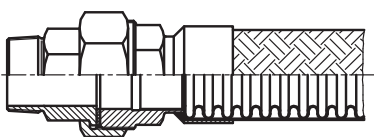



WILLBRANDT Fabric Compensator Type 300-GEW

Type 300 is a highly flexible expansion bellow that is a long-established design element in the areas of power generation (coal, oil and nuclear power plants, gas turbine peak-load power stations), ore dressing (blast furnace and sintering plants), cement industry, air conditioning and materials handling technology (fans and blowers, in pneumatic and vibrating conveyor plant), in shipbuilding, apparatus and motor construction and many other branches of industry. It compensates for heat expansion in all planes and absorbs mechanical and acoustic oscillations or vibrations.

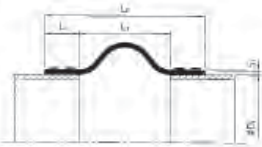
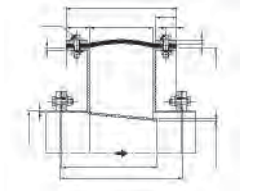

Standard Design

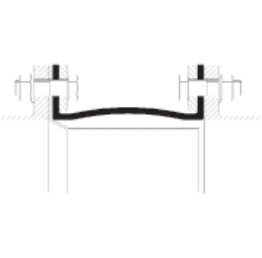
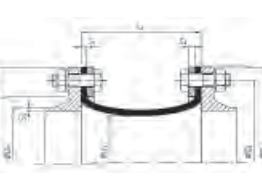
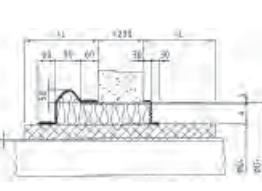
	<p>1</p> <p>The simplest form of a GEW compensator, but only suitable for round duct and positive pressure. (In the case of square ducts, the pipe must be drilled. Negative pressure will cause the compensator to contract and reduce the duct sectional area). Media temperature up to 300°C Positive pressure up to 2000 mm WC Dimension „R“ : 4 times expansion absorption (minimum dimension 40 mm).</p>
	<p>2</p> <p>With this design the majority of expansion problems can be solved efficiently. Square ducting does not need to be spot-drilled, no reduction in pipe cross section at negative pressure, good temperature reduction in the fixing areas with an increase in the „i.W.“ measurement, simple mounting (due to the shape of the fastening) also for subsequent installation. For round, square or oval ducting at positive and negative pressure. Media temperature up to 600°C Positive pressure up to 3000 mm WC. Contact us in case of higher pressures! Dimension „R“ : 4 times expansion absorption (minimum dimension 40 mm).</p>
	<p>3</p> <p>As for design 2, but for very high temperatures with glass wool insulation (acid resistant) between compensator and deflector sleeve. For round, square or oval ducting at positive and negative pressure. Media temperature up to 1000°C Positive pressure up to 2000 mm WC Dimension „R“ : 4 times expansion absorption (minimum dimension 40 mm).</p>
	<p>4</p> <p>This design is recommended if mounting flanges are to be used (e.g. for a ventilator), at higher pressure or if a reduced overall length is required. For all ducting cross-sections. Media temperature up to 300°C (for higher temperatures, increase distance between deflector sleeve and compensator) Positive pressure up to 5000 mm WC Dimension „E“ : 3 times expansion absorption ; Δl - axial Dimension „E“ : 4 times lateral offset (radial displacement), if this is greater than the axial expansion absorption (minimum dimension 80 mm).</p>
	<p>5</p> <p>As for design 4, but only for negative pressure. Increased distance between required compensator and deflector sleeve, to avoid fabric abrasion. Media temperature up to 350°C (for higher temperatures, increase distance between deflector sleeve and compensator). Negative pressure up to 4000 mm WC Dimension „E“ : 3 times expansion absorption ; Δl - axial Dimension „E“ : 4 times lateral offset (radial displacement), if this is greater than the axial expansion absorption (minimum dimension 80 mm).</p>
	<p>6</p> <p>This design is recommended for wall and ceiling ducting for non-flammable pipes subject to axial, lateral and angular movement. On both sides the compensator has a wall and ceiling ending with diaphragm in silicone rubber without fabric lining and opposite compensator with fabric liner. Certified acc. to DIN 4102, part 11 MPA Braunschweig Nr. P-3740/4280-MPA BS</p>

Planning, Installation and Maintenance Instructions for Rubber Compensators with Rotary Flanges and Solid Flanges

WILLRANDT Rubber Compensators will be supplied ready for installation in two designs. Once with one-piece swivel steel retaining flanges, in accordance with the standard interface (DIN, ASA, BS etc.)

These flanges should fit neatly, without any burr within the clamping range of the rubber bellow with a rubber sealing surface protruding about 1 -10 mm, depending on the nominal width. The counterflange sealing surfaces may be designed smooth or rather with sealing face, according to EN 1092 - 1:2001 (form A or B).

The second group will be supplied with pressure-strengthened solid rubber flanges including one-piece steel retaining flanges in accordance with the standard connection (DIN, ASA, BS, etc.). The counter flanges should be designed with smooth sealing surface.

Both compensators are self-sealing, additional gaskets are not required.

1. Planning instructions

The lines must be designed in such a manner that the compensators are guided by fixed bearings (FP) or sliding bearings (GL); see:

Installation example 1

Compensating of axial expansion with unbraced compensators.

Installation example 2

Compensating lateral and axial expansion with an unbraced compensator.

Installation example 3

Compensating of lateral and axial expansion with unbraced compensators at an outgoing pipe.

Installation example 4

Compensating of axial expansion by angular movement reversal with braced compensators. Advantage: Large axial expansions can only be absorbed by two compensators.

Installation example 5

Arrangement of pipe hinge compensators in three hinge systems for absorbing expansion in two directions. Advantage: High expansion absorbing rates, low adjusting forces, a soft corner.

Installation example 6

Use of rubber compensators with pumps. In this case compensators in the pressure line should always be braced to ensure that internal pressure does not overload the pump connecting piece. A vacuum bearing ring should be used on the suction side if the negative pressure exceeds 0.8 bar, absolute.

2. Bracing examples

Rubber compensators in order to take up axial must be installed between fixed points expansion. The axial and lateral expansion must be transformed where this is not possible so that braced rubber compensators can be used to neutralize the arising reaction forces (inside surface of the compensator multiplied by the operating pressure). In this arrangement only appropriate sliding bearings can be used for correct introduction of the expansion.

An extensive range of rubber compensator bracings is listed in our catalogue.

3. IMPORTANT

When conveying abrasive media (liquids containing solids, e.g. water/sand) the compensators must not be directly attached to the pump connecting piece (suction/pressure side), due to a risk of the compensators being damaged by the relatively high speeds associated with the twist and whirl formations in the pump connecting piece. This also applies to bent pipes and tailings.

EB 7

The installation space between the pump connecting piece and compensator must be 1 to 1.5 times the nominal diameter (DN). Pump operation against a totally or partially closed gate or flap valve must be avoided. Cavitation must also be avoided as this can result in the rapid destruction of the compensator.

EB 8 (Axial prestress)

With axial prestress it is necessary to ensure that the compensators are prestressed by not more than maximum 10 mm when in a non-installed state. For higher prestresses a compensator in conformity with **EB 8** must be used, i.e. the compensator must be first fully installed after which the corresponding prestress is generated with the firmly installed compensator.

Reason: With a higher prestress in a non-installed state, the sealing bead can spring out of the holder of the steel backing flange and damage the sealing bead in the process.

EB 8 (Lateral prestress)

For compensator arrangement, it must be ensured when dimensioning the pipe that any necessary lateral prestress must be applied only with a securely installed compensator by means of pipe misalignment (**EB 8a**). A lateral prestress of only 5mm is possible prior to installation. It must however be ensured that the rubber bead is not pulled out of the groove in the steel backing flange.

EB 9

Regarding rubber bonded pipes or fittings rubber bonded with a rubber to rubber gasket is to avoid by using isolation disk.

4. Safety measures

The pipes must be protected against impermissible overpressure, excessive rise of temperature and uncontrolled vacuum. The limiting values for the respective settings are shown in the data sheets of our catalogue relating to the respective types. In addition, appropriate drain and venting options should be provided to prevent water impact and vacuum failures, which can also cause compensator damage.

Medium safety

Since the inside of the compensator comes into contact with the media, it must be ensured that only media is pumped as specified in the resistance list as suitable for the inner rubber.

If other media are used we should be notified of the same together with the relevant data in accordance with the safety data sheet for chemical substances and preparation as per DIN 52900, Item 1 to 2.13, in order that we may ascertain whether the inner rubber of the compensator is suitable.

Flow rates

With high flow rates it is necessary to clarify whether the compensators have to be installed with or without a guiding pipe to avoid wear as a result of excessive whirling.

Mating flanges

Mating flanges must conform in their design with **EB 10** to ensure reliable sealing and clamping of the rubber compensators.

Counter flanges with or without protrusion may be used for compensators with swivel flanges in accordance with EN EN 1092-1:2001 form A or B. There should only be used smooth counter flanges for compensators with solid flanges.

Vacuum supporting ring (EB15)

With application of vacuum supporting rings it must be observed that the vacuum supporting rings will be checked up on right positioning after assembly when application is directly behind the pump, damper or pipe elbow.

- a. exact fit (max. 10 - 15 mm play between bellow and ring onesided).
- b. Where necessary insertion of adapter plates to achieve the acceptable play of seating.
- c. The connection lock should always lay in the lower flow range (6°).
- d. With high velocity flow it should always be checked whether a compensator with vulcanized supporting ring should be applied to avoid possible vibration crackings by strong turbulent flows.
- e. After assembly please check whether the hexagon socket wrench and the hexagon nuts are secured accordingly against loosening.

5. Transport

Packaging Package parts.

Note „TOP" at the top and „cable or lifting hook" steel backing rings (with bracing) and the rubber compensator flanges must remain fastened until final mounting. The relatively light rubber part is bonded to heavy metal flanges - avoid excessive loading of the rubber part.

Tools

No sharp-edged tools, wire cables, chains or lifting hooks (danger of damage to rubber).

Lifting and moving

Always lift both steel flanges simultaneously. Shackle at both sides or place padded tie-bars through the compensator or lift both sides.

Ground level transportation

Move flanges by rolling.

6. Installation

- 6.1 Check the packaging of the rubber compensators for damage. Damaged compensators must never be released for installation.
- 6.2 Check the envisaged installation gap. The mating flange must be installed in true alignment. The maximum deviation within the installation gap in relation to the compensator is +10 mm, minus the corresponding expansion specifications. The maximum lateral deviation of the flange is 5 mm.
- Note:** If it is not possible to observe the above tolerances then proceed with an axial/lateral prestress as defined by **EB 8 / EB 8a**.
- 6.3 Do not use sharp-edged tools. Additional gaskets are not required. The compensator rubber flange seals directly on to the pipe flange.
- 6.4 Fasten the compensator at both flanges with e.g. 2 threaded rods before loosening the lifting device.
- 6.5 **Arrangement of the screws EB 10**
For compensators that have through-holes the screw heads must face the bellow to avoid damaging the bellow body when under pressure. For compensators with threaded holes in the flange, the screws must fit flush with the inner side of the flange in relation to the bellow so that protruding screws cannot damage the bellow when under pressure.

- 6.6 The flange screws must be evenly tightened in alternation as shown in Table 1 and 2 (page 69/70). It must also be ensured that the sealing bead does not tilt. The entire protruding sealing surface must be uniformly compressed. The screws must be evenly tightened crosswise 3-4 times.
- 6.7 **Tightening with a torque wrench**
Evenly tighten all screws manually (step 1) (ensure parallelism with the sealing surfaces). Then step 2 and 3 crosswise (acc. to table 1 and 2 page 69/70). After the third stage, 30 minutes should be allowed to pass before retightening to the final torque specified in step 3. Further tightening of the screws is unnecessary, particularly since this could destroy the surface seal.
- 6.8 Do not use plain washers on steel backing flanges.
- 6.9 Do not weld close to the rubber compensator. If necessary, cover the compensator with asbestos for protection against welding heat and flying sparks (sparks and temperatures above 80°C will damage the rubber parts!).
- 6.10 **Attention:**
When welding, steel-wire compensators throughout the whole piping system can be damaged by current leakage or electrical earthing. The anode and cathode of the E welding connection must always be on the same section of piping. (Not separated by the rubber compensator!).
- 6.11 **Attention: Bellow**
Bellow must not be painted or insulated by a temperature above 50°C. Heating and hardening of the rubber.

7. Pipe leading

Anchor points and mountings

Prior to filling the piping, it must be ensured that all anchor points and mountings are installed and operational. The bracing anchors must provide uniform support and must be adjusted to the existing piping.

8. Final installation inspection

8.1 Damage

Check complete compensators for visible damage and in particular clean the gap between the steel backing flange and rubber bellow (remove foreign bodies, sand, etc.).

8.2 After the compensators have been installed they should be protected in an appropriate manner against damage, and the protection should only be removed just before putting into operation.

8.3 The rubber parts must not be over-painted. Solvents and chemicals will attack the surface and destroy the bellow.

8.4 The compensators must not be insulated as this can result in overheating and drying the bellow and damage to the same.

8.5 The best operating results are achieved when the compensator operates stress-free under operating conditions (take appropriate prestressing into account during installation).

8.6 The fixed points must be checked to see whether they are suitable for absorbing the reaction force from the non-braced compensator or whether the adjusting forces and initiation of expansion with appropriate sliding bearings take place at the correct distance from the compensator.

8.7 Compensators braced with tie rods should be appropriately adjusted following installation. The tie rods should be able to be turned hand-tight. All hexagon nuts must subsequently be locked with lock nuts.

8.8 After mounting check the supporting rings on the right seat and fuse.

8.9 Leakages

Tighten bolts when possible leakages occur during pressure testing (1.3 x design pressure).

9. Pressure test

The rubber compensator is not a proper pressure vessel, but is classified according to the Pressure Equipment Directive as a "pipe accessory" (pipe component). When including the compensator in the pipeline, sealing does not take place via a separate seal, but directly on the integrated surface seal of the rubber bellow.

A one hundred per cent pressure test of the rubber compensators at the manufacturer can adversely influence the integrated rubber sealing surface. For this reason, pressure testing of the rubber compensators at the manufacturer takes place only at the special request of the customer with the utmost care.

The pressure test is normally carried out only after the rubber compensators have been fully installed in the pipeline system. The information contained in these installation instructions should be observed prior to the pressure test.

10. Storage

See DIN 7716 - guidelines for the storage of rubber parts: Rubber compensators must be stored free of stress, deformation and bending. Rubber compensators with steel flanges must be stored upright on the flanges (to avoid the risk of crushing).

Storage room

The storage room must be cool, dry, dust-free and moderately ventilated.

Oxygen and ozone

Rubber parts must be protected from draughts. If necessary they should be covered. Do not operate any ozone-generating facilities in the storage room, e.g. electric motors, fluorescent lamps, etc.

Other jointly stored media

Do not store solvents, fuels, chemicals or similar substances in the same storage room.

11. Supplementary installation and mounting instructions for type 45 - 46 (EB 11)

The type 46 rubber compensator should be installed free of any tension. Screws should always be tightened with two wrenches to avoid damaging torsions being transmitted to the compensator; see **EB 11**.

Installation procedure

1. Attach the screw-joining parts to the pipe and check the installation gap! The installation gap must equal the compensator length (130 mm +5 mm).
2. Insert the compensator and tighten with two wrenches.

Nominal diameters DN 20 - 25

The front screw-in part is used as a steady while the union nut is tightened (to avoid the transmission of torsions to the bellow).

Nominal diameters DN 32 - 50

The rear screw-in part is used as a steady while the union nut is tightened (to avoid the transmission of torsion to the bellow).

See main installation instructions for all other installation points.

Tightening torque for all types 100 Nm.

12. Additional installation and assembly instructions for pressure balanced compensators

Compensators for receiving axial extension without reaction forces are transferred from high or low pressure on the adjacent bearing, equipment or machinery (**EB 12**).

Compensators to accommodate axial- and lateral extension in a pipe elbow without that the reaction forces are transferred from positive and negative pressure on the adjacent bearing (**EB 13**).

13. Additional installation and assembly instructions for compensators as dismantling device

In order to balance imprecise assembly on valves or for simple installation and removal tight joints may be used. On the one hand the tensions prevent the transfer of reaction forces on the connected valve. On the other hand after loosening the flange connection by means of the restraint flange the rubber bellow can be compressed by its maximum possible axial movement in order to create space for dismantling the valve (**EB 14**).

14. Maintenance and Monitoring

- 14.1 Before final commissioning, check the tightening torque of the flanged joints.
- 14.2 Rubber parts must not be painted and should be kept clean. (Clean with water or soapy water). Keep the parts free from grease and oil.
- 14.3 Rubber parts should not be insulated when the temperature exceeds 50°C. (Heating and hardening of the rubber.)
- 14.4 Inspection must be carried out minimum one week after commissioning. Tighten flange bolts with torque wrench. Inspections must be carried after 1,4 and 12 months, then annually.
- 14.5 Inspection criteria
 - External damage to rubber and bracing.
 - Deformation of rubber flange external diameter between the bolts (flange surface displacement).
 - Variations in the rubber bellow (blister formation, brittleness, fissures, hairline cracks)
 - Check bracing for excessive movement and misalignment.

Assess corrosion and wear over the whole component.

Installation Examples

EB 1

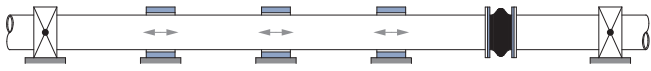

EB 2

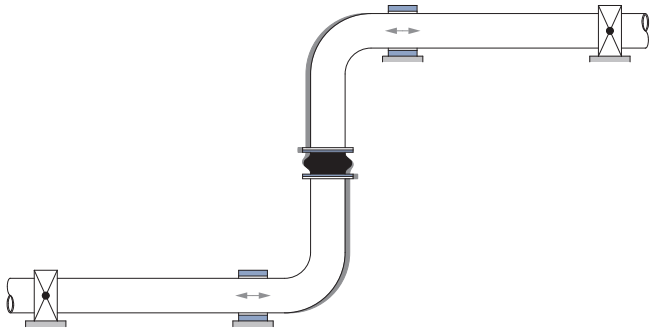

EB 3

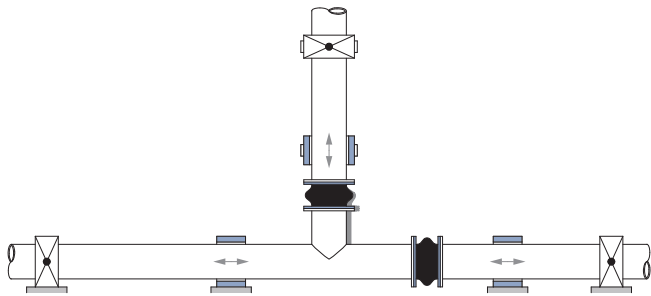

EB 4

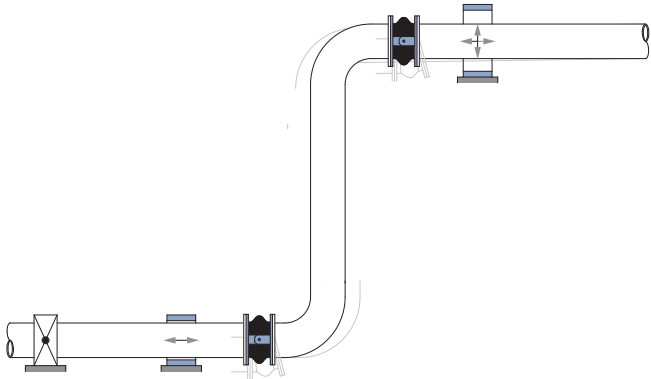

EB 5

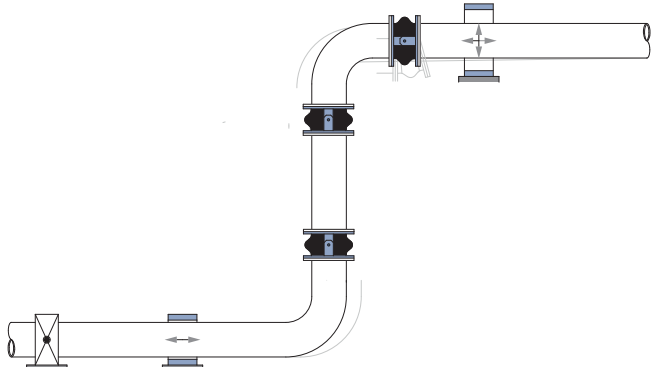

EB 6

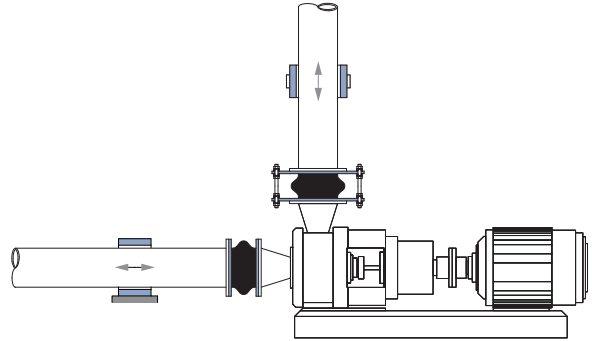

EB 7

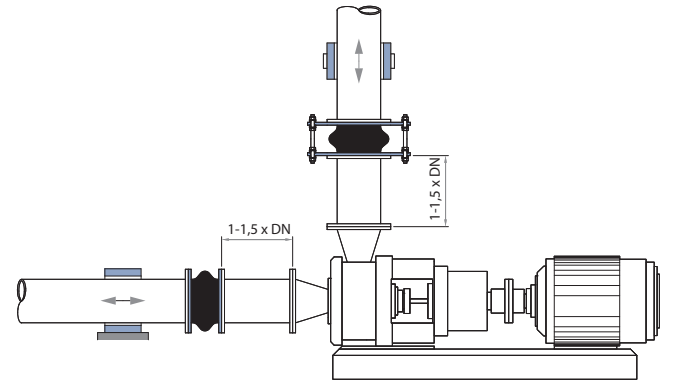

EB 8

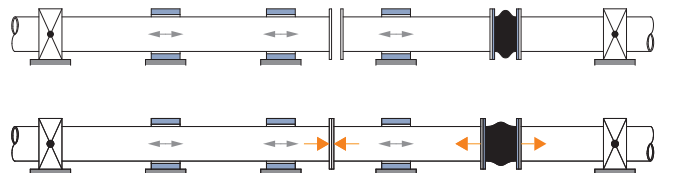

EB 8 a

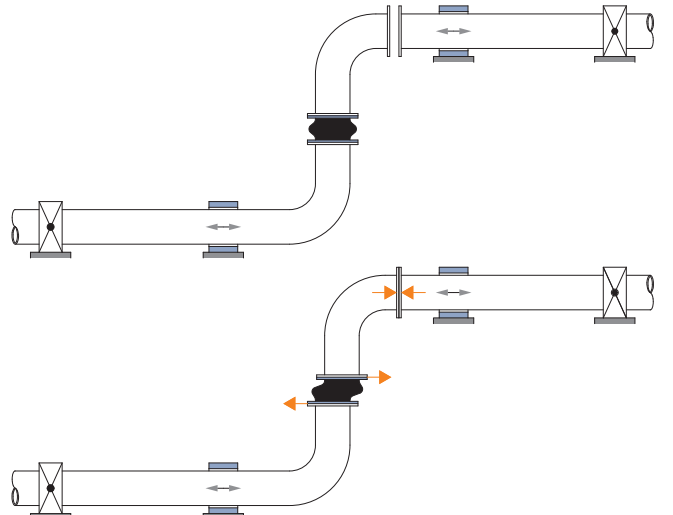

EB 9

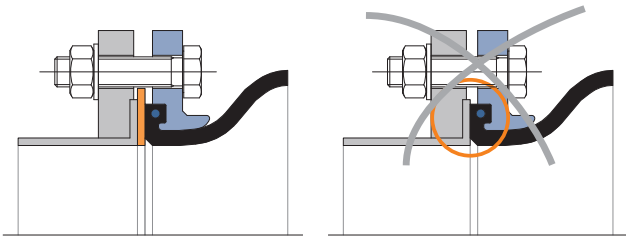

EB 10

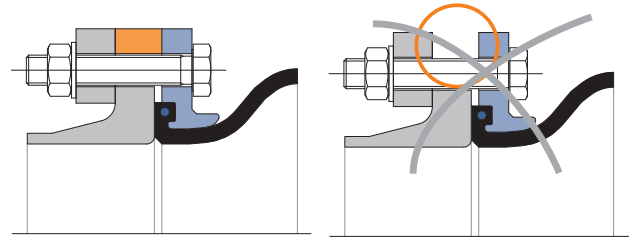

EB 10

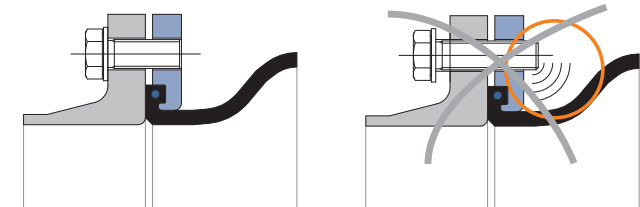
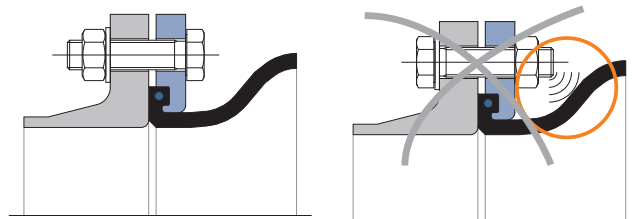
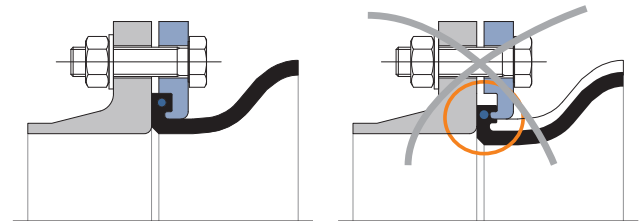
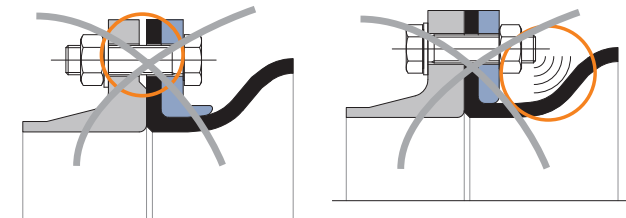
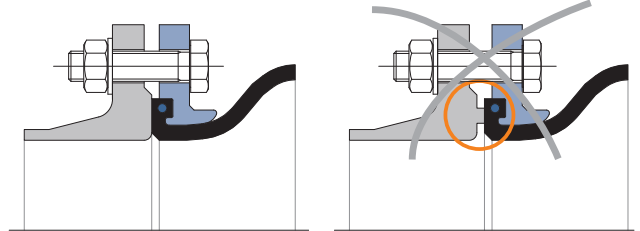
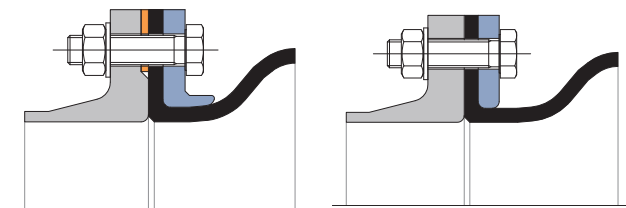
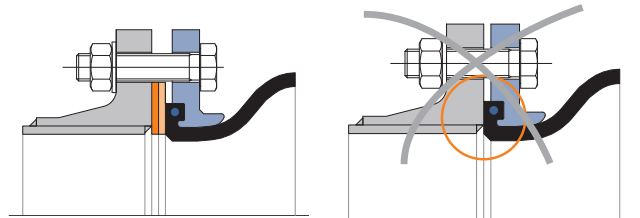
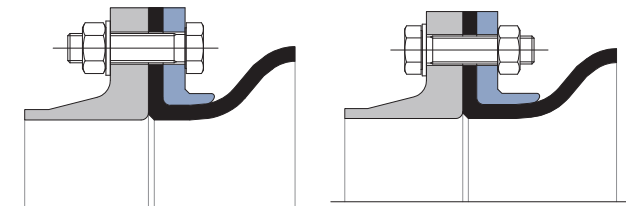
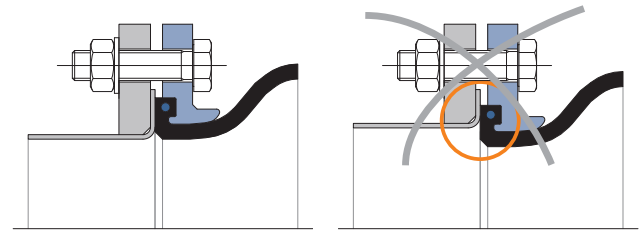
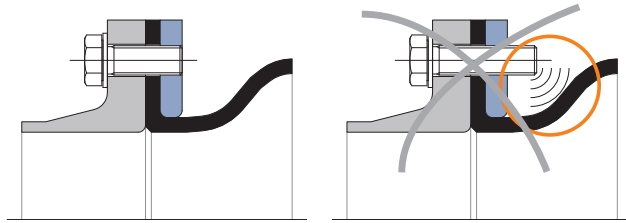

EB 11

DN 20/25 Typ 46 / DN 20 - 50 Typ 50

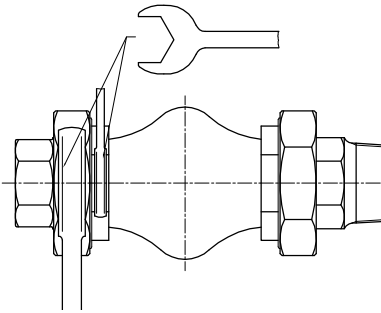
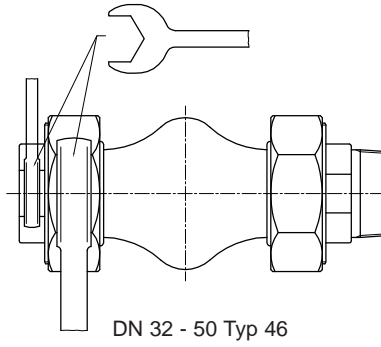

EB 14

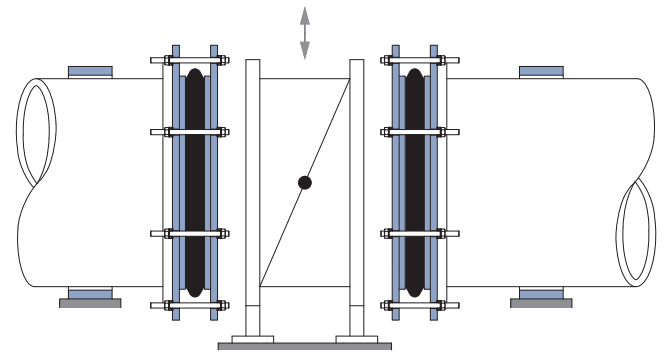
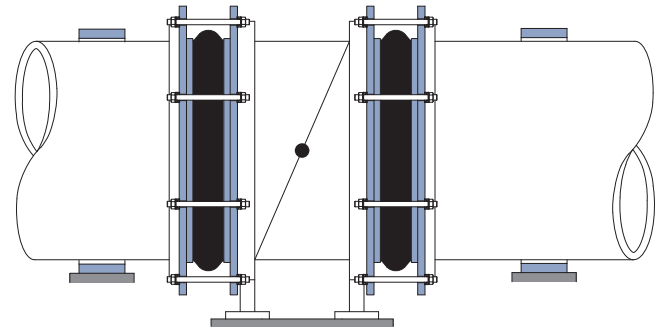

EB 12

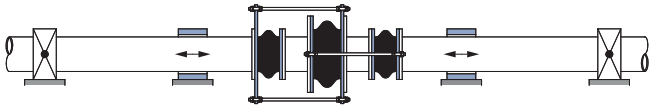

EB 15b

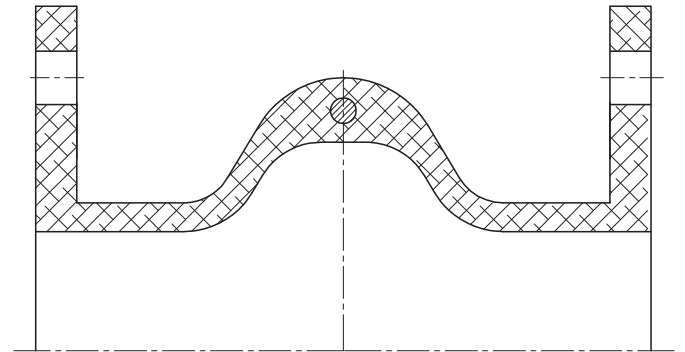

EB 13

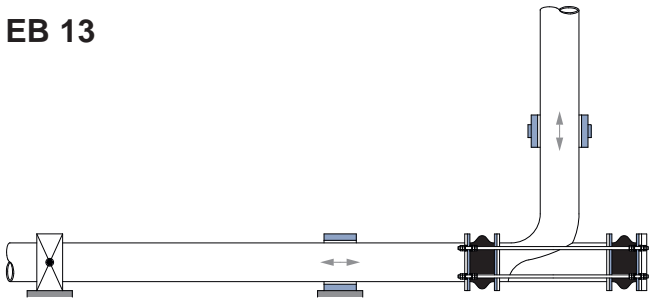

EB 15a

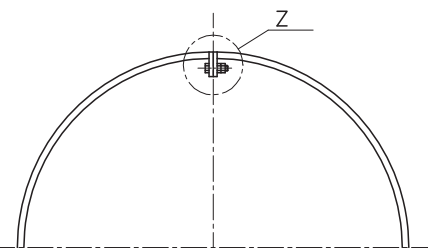

Detail Z

DN400 bis DN1100

ab DN1200 und >

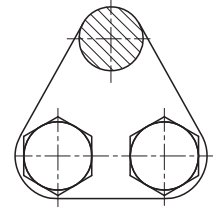
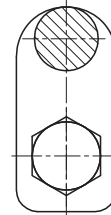
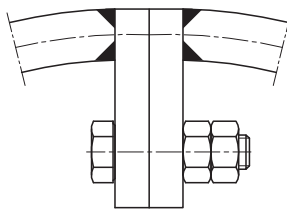

DN400 bis DN1100

ab DN1200 und >

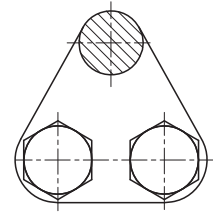
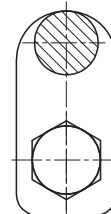
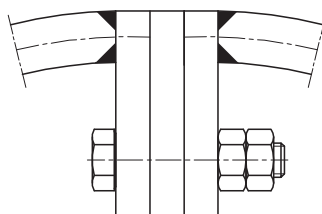

Flange Bolt Torque (Nm)

Installation information

Tools: Torque-wrench, rubber hammer, centre punches. All tools to be burr-free (danger of damage to rubber parts)

Use **flange bolts** with **property class 8.8** (new bolts, greased).

- Step I
 - a) insert all bolts and tighten equally by hand.
 - b) Fasten with about 3 crosswise and uniform turns at torque step I . Check gap width at outer edge of flange.
 - c) Settling time 30 minutes.
- Step II
 - d) Tighten all bolts crosswise by 3 turns as per table above or 2/3 of final torque. Check gap width.
 - e) Settling time > 60 minutes.
- Step III
 - f) Tighten crosswise 2 turns at final torque.
DO NOT TIGHTEN FURTHER!

Before test pressure: check torque 1 turn crosswise with final value (Step III).

Later inspections: follow service manual. Only tighten flange bolts to final value (Step III).

Flange tightening torque

The flange bolt torques given in the table provide a specific surface pressure of 7 N/mm² relative to the total surface of the compensator flange (use flanges without seal). Because of the temporary settling process in the rubber flange area the surface pressure falls under working conditions to some 50% of the final value (step III). The residual effective gripping and sealing force is completely sufficient and suitable for test pressures up to 16 bar (tensile stresses from over-expansion **are not permissible!**).

Attention: The maximum tightening torques given must not be substantially exceeded, since an excessive load causes a constant increase in the flow in elastomer and leads to destruction (crushing).

Torque: Rough estimation of the final tightening torque for special flanges

Rule of thumb

- M_A = $0.2 \cdot F_{VM} \cdot d_2$
- M_A = Bolt Tightening Torque
- d_2 = Screw Thread Flanks-Ø 1.4
- F_{VM} = Installation Prestress Force = $K_A \cdot F_{KL}$
- *KA = Tightening Factor ~ 1.4 greased, against a firm support
- KA = Experimental Value = 1.0 selected flow process in rubber flange
- FKL = Clamping Force, Contact Pressure 7 N/mm² for total flange surface for Type 40

$$F_{KL} = \left(\frac{\text{Flange } D^2 - DN^2}{4} \right) \times \pi \times \frac{\text{Contact Pressure x (N)}}{\text{Number of bolts}}$$

Flange Bolt Torque for Type 40, 42, 58, and 59 (table 1)

DN	Step 1	Step 3				Step 3			
	Pre-assembly	PN 6	PN 10	PN 16	ASA 150	PN 6	PN 10	PN 16	ASA 150
	Nm	Nm	Nm	Nm	Nm	Nm	Nm	Nm	Nm
200	100	160	200	160	200	200	250	200	250
250	100	160	160	200	200	200	200	250	250
300	150	160	160	240	280	200	200	300	350
350	150	200	160	200	360	250	200	250	450
400	150	160	240	280	320	200	300	350	400
450	150	200	160	280	360	250	200	350	450
500	150	160	240	360	360	200	300	450	450
550	200				400				500
600	200	240	320	520	480	300	400	650	600
650	200				440				550
700	200	240	320	440	440	300	400	550	550
750	250				480				600
800	250	320	440	560	640	400	550	700	800
850	250				600				750
900	250	360	440	520	640	450	550	650	800
950	250				720				900
1000	250	360	560	720	680	450	700	900	850
1050	250				720				900
1100	250				720				900
1150	250				720				900
1200	250	440	680	960	720	550	850	1200	900
1250	250				880				1100
1300	250				920				1150
1350	250				1000				1250
1400	250	560	840	1000	960	700	1050	1250	1200
1450	250				1040				1300
1500	250				1000				1250
1600	250	600	1120	1360	920	750	1400	1700	1150
1650	250				1160				1450
1800	250	680	1120	1360	1120	850	1400	1700	1400
1950	250				1320				1650
2000	250	840	1160	1560	1480	1050	1450	1950	1850
2100	250				1520				1900
2200	250	880	1480		1640	1100	1850		2050
2250	250				1840				2300
2400	250	920	1520		2040	1150	1900		2550
2550	250				2320				2900
2600	250	1120	1560		2560	1400	1950		3200
2700	250				2560				3200
2800	250				2680	1450	2050		3350
2850	250				2960				3700
3000	250	1160	1880		3200	1450	2350		4000

DN < 3000 - 5000 on request

Flange Bolt Torque for Type 48, 48, 50, 51, 53, 55, 56 and 65 (table 2)

DN	Step 1 for all	Step 2 for all	steü 3				
			PN 6 Nm	PN 10 Nm	PN 16 Nm	PN 25 Nm	ASA 150 Nm
25	by hand	50	60	80	80	80	80
32	by hand	50	60	80	80	80	80
40	by hand	50	60	80	80	80	80
50	by hand	50	60	80	80	80	80
65	by hand	50	60	80	80	80	80
80	by hand	50	60	80	80	80	80
100	by hand	50	80	100	100	100	100
125	by hand	50	80	100	100	100	100
150	by hand	50	80	100	100	100	100
175	by hand	50	90	100	100	100	100
200	by hand	50	90	100	100	100	100
250	by hand	50	90	100	100	110	100
300	by hand	50	100	110	110	110	100
350	by hand	50	120	130	135	165	110
400	by hand	50	120	140	155	200	140
450	by hand	50	140	145	165	200	145
500	by hand	50	120	145	170	200	145
600	by hand	100	185	210	255	280	210
700	by hand	100	200	225	300	300	230
800	by hand	100	235	300	360	410	300
900	by hand	100	235	300	360	415	300
1000	by hand	100	300	360	425	525	360

See installation information.

Installation and Maintenance Information for Type 64

Storage

The compensators should be stored under clean and dry conditions and must be protected against mechanical damage. Do not unpack the compensator until ready for installation. Protective covers should be left on as long as possible. Transportation support devices must not be removed until the compensator is in position in the pipeline system.

Installation

Do not start installation until all work on the ducting and flanges has been completed and all anchors and supports have been fitted. This serves to prevent any damage to the compensator through welding sparks, sharp objects etc. and ensure that the compensator is not over-stressed.

The bellow must not be painted or insulated.

The compensators are manufactured from highly flexible materials. The durability depends on careful and correct installation. Sharp edges and folds must be avoided and care must be taken when lifting compensators during installation.

It is recommended to use a supporting plate or an internal frame for lifting purposes. Preferably, a compensator should be pre-assembled with backing flanges and internal sleeve (if included in the delivery) on the ground before lifting.

Ducting flanges / tolerances

If the delivery includes ducting flanges, backing flanges or other steel parts, check that the measurements correspond with the drawings and that bolt holes are arranged symmetrical in each flange.

The bolts must be retightened 24 hours after installation of the compensator.

Plates for the assembly of compensators with welding flanges.

Bolt torque

Backing flanges bolts	40 x 10 M10	50 x 10 M12	60 x 10 M12	60 x 12 M16
NBR	60 Nm	70 Nm	80 Nm	80 Nm
EPDM	60 Nm	80 Nm	80 Nm	80 Nm
VITON		80 Nm	80 Nm	80 Nm

Spacer for Install Rubber Expansion Joints with Slip-on Flanges

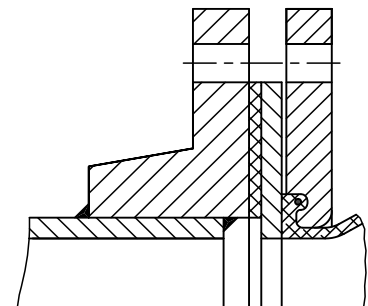
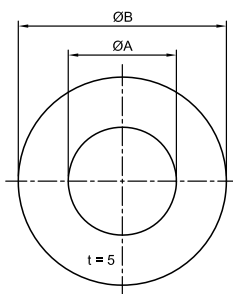

DN 32		DN 40		DN 50		DN 65		DN 80		DN 100		DN 125		DN 150		DN 175		DN 200		DN 250		DN 300	
A	B	A	B	A	B	A	B	A	B	A	B	A	B	A	B	A	B	A	B	A	B	A	B
32	82	40	92	50	107	65	127	80	142	100	162	125	192	150	218	175	248	200	273	250	328	300	378

Installation Instructions for Type 80

1. Protective covers

These serve to protect the beading sealing surface against mechanical damage and must only be removed directly prior to assembly. If removal for the purpose of inspection is necessary, the protective covers must subsequently be bolted tight.

2. Welding, soldering and brazing on the lined components is not permitted as this can damage the high-quality lining and give rise to the release of highly toxic gases.

3. The use of seals between PTFE/PTFE sealing faces is unnecessary. For connections to glass, ceramics, enamel and other components, an approximately 5 mm thick PTFE seal is recommended.

4. Installation

To prevent deformation of the sealing faces through overtightened bolts, the following torques should be referred to as a guide during assembly. (The values apply to flanged joints up to PN 25 for bolts with lubricated thread.)

The bellow must not be painted or insulated.

5. Painting / Insulation

The compensator bellows must not be insulated or painted. Splash protection covers must be fitted so that heat accumulation in the area of the bellow is avoided through heat transmission.

6. Commissioning

After reaching operating temperature, the flange connections should be retightened with the specified torque. In case of leakages, the flange connections must be checked for parallelism or soiling or damage of the sealing face. Minor indentations or damage can be removed with emery cloth.

7. Installation of compensators

In addition to the aforementioned, the tie rods must not be removed after adjustment to maximum expansion or after installation.

Flange connection dimensions according to DIN 2501

DN	PN 10			PN 25		
	Quantity	Thread	Md NM	Quantity	Thread	Md NM
20	4	M 12	10	4	M 12	10
25	4	M 12	20	4	M 12	20
32	4	M 16	30	4	M 16	30
40	4	M 16	40	4	M 16	40
50	4	M 16	50	4	M 16	50
65	4	M 16	70	8	M 16	40
80	8	M 16	40	8	M 16	40
100	8	M 16	40	8	M 20	50
125	8	M 16	50	8	M 24	80
150	8	M 20	60	8	M 24	90
200	8	M 20	90	12	M 24	100
250	12	M 20	60	12	M 27	120
300	12	M 20	70			
350	16	M 20	110			
400	16	M 24	160			
500	20	M 24	180			
600	20	M 27	240			
700	24	M 27	260			

Sealing Profile of the Rubber Bellows

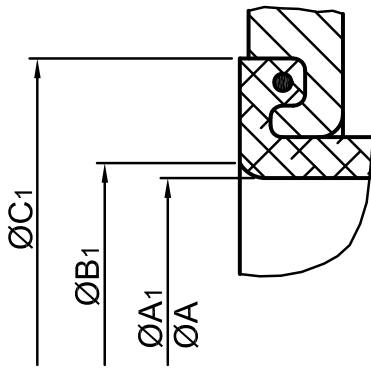

Type 50
Type 53
Type 55 Design E

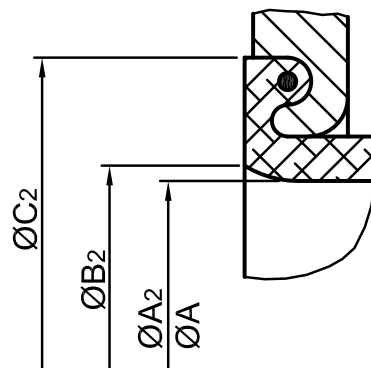

Type 39
Type 55 Design S

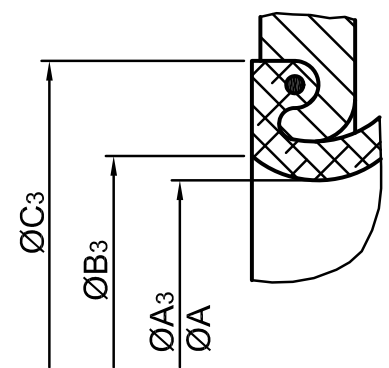

Type 49

DN	Type 55				Type 50/53				Type 49				Type 39			
	C _{1/2}	^{±2} B _{1/2}	^{±2} A _{1/2}	~ A/D	C ₁	^{±2} B ₁	^{±2} A ₁	~ A/D	C ₃	^{±2} B ₃	^{±2} A ₃	~ A/D	C ₂	^{±4} B ₂	^{±4} A ₂	~ A/D
25	65	37	28.5	30	65	37	28.5	30								
32	65	37	28.5	30	65	37	28.5	30	79	42	35	37				
40	74	42	36	39	74	42	36	39	79	42	35	37	79	42	36	39
50	92	55	45	48	92	55	45	48	89	57	45	47	89	55	45	48
65	105	71	60.5	64	105	71	60.5	64	104	69	59	61	104	71	60.5	64
80	118	81	74	77	118	81	74	77	119	86	75	77	119	81	74	77
100	137	106	94	98	137	106	94	98	142	110	98	100	149	106	94	98
125	166	132	121	125	166	132	121	125	169	137	125	127	169	132	121	125
150	192	160	147	151	192	160	147	151	195	164	149	151	195	160	147	151
175									220	182	173	175	220			
200	252	213	202	206	252	213	202	206	245	200	197	200	245	202	195	199
250	304	257	250	254	304	257	250	254	295	256	252	255	298	247	244	248
300	354	309	300	304	354	309	300	304	345	304	299	302	351	302	298	302
350	412	350	330	340	412	350	330	340	396	358	354	357	412	340	330	330
400	470	414	404	408	470	414	404	408	450	405	402	405	470	410	390	390
450	512	445	445	450									512	449	439	439
500	570	514	504	508	570	514	504	508	550	508	504	507	570	500	490	490
600	675	611	603	607	675	611	603	607					675	597	587	587
700	780	708	680	695	780	708	680	695					780	701	691	691
800	887	813	801	805	887	813	801	805					887	801	791	791
900	985	907	897	900	985	907	897	900					985	898	888	888
1000	1085	1007	997	1000	1085	1007	997	1000					1085	998	988	988

Flange Mating Dimensions

DN	PN 6				PN 10				PN 16				PN 25				ASA 150 lb.				DN inch
	øD mm	øpc mm	n	ød mm	Thread d	øD mm	øPC mm	n	ød mm	Thread d	øD mm	øpc mm	n	ød mm	Thread d	øD mm	øpc mm	n	ød mm	Thread d	
25	100	75	4	11	M10	115	85	4	14	M12	115	85	4	14	M12	115	85	4	14	M12	
32	120	90	4	14	M12	140	100	4	18	M16	140	100	4	18	M16	140	100	4	18	M16	
40	130	100	4	14	M12	150	110	4	18	M16	150	110	4	18	M16	150	110	4	18	M16	
50	140	110	4	14	M12	165	125	4	18	M16	165	125	4	18	M16	165	125	4	18	M16	
65	160	130	4	14	M12	185	145	4	18	M16	185	145	4	18	M16	185	145	4	18	M16	
80	190	150	4	18	M16	200	160	8	18	M16	200	160	8	18	M16	200	160	8	18	M16	
100	210	170	4	18	M16	220	180	8	18	M16	220	180	8	18	M16	220	180	8	18	M16	
125	240	200	8	18	M16	250	210	8	18	M16	250	210	8	18	M16	250	210	8	18	M16	
150	265	225	8	18	M16	285	240	8	22	M20	285	240	8	22	M20	285	240	8	22	M20	
175	295	255	8	18	M16	315	270	8	22	M20	315	270	8	22	M20	315	270	8	22	M20	
200	320	280	8	18	M16	340	295	8	22	M20	340	295	12	22	M20	340	295	12	22	M20	
250	375	335	12	18	M16	395	350	12	22	M20	405	355	12	26	M24	425	370	12	30	M27	
300	440	395	12	22	M20	445	400	12	22	M20	460	410	12	26	M24	485	430	16	30	M27	
350	490	445	12	22	M20	505	460	16	22	M20	520	470	16	26	M24	555	490	16	33	M30	
400	540	495	16	22	M20	565	515	16	26	M24	580	525	16	30	M27	620	550	16	36	M33	
450	595	550	16	22	M20	615	565	20	26	M24	640	585	20	30	M27	-	-	-	36	M33	
500	645	600	20	22	M20	670	620	20	26	M24	715	650	20	33	M30	730	660	20	36	M33	
600	755	705	20	26	M24	780	725	20	30	M27	840	770	20	36	M33	845	770	20	39	M36	
700	860	810	24	26	M24	895	840	24	30	M27	910	840	24	36	M33	960	875	24	42	M39	
750	-	-	-	-	-	-	-	-	-	-	-	-	-	-	-	-	-	-	-	-	
800	975	920	24	30	M27	1015	950	24	33	M30	1025	950	24	39	M36	1085	990	24	48	M45	
900	1075	1020	24	30	M27	1115	1050	28	33	M30	1125	1050	28	39	M36	1185	1090	28	48	M45	
1000	1175	1120	28	30	M27	1230	1160	28	36	M33	1255	1170	28	42	M39	1320	1210	28	56	M52	
1100	1290	1230	28	33	M30	1345	1270	32	36	M33	1370	1280	28	48	M45	-	-	-	-	-	
1200	1405	1340	32	33	M30	1455	1380	32	39	M36	1485	1390	32	48	M45	1530	1420	32	62	M56	
1300	1520	1450	32	36	M33	1565	1485	32	42	M39	1585	1490	36	48	M45	-	-	-	-	-	
1400	1630	1560	36	36	M33	1675	1590	36	42	M39	1685	1590	36	48	M45	1755	1640	36	62	M56	
1500	1730	1660	36	36	M33	1795	1705	36	48	M45	1810	1705	36	56	M52	-	-	-	-	-	
1600	1830	1760	40	36	M33	1915	1820	40	48	M45	1930	1820	40	56	M52	1975	1860	40	62	M56	
1700	1940	1865	40	39	M36	2015	1920	44	48	M45	2030	1920	44	56	M52	-	-	-	-	-	
1800	2045	1970	44	39	M36	2115	2020	44	48	M45	2130	2020	44	56	M52	2195	2070	44	70	M64	
1900	2155	2075	44	42	M39	2220	2125	48	48	M45	2240	2125	44	62	M56	-	-	-	-	-	
2000	2265	2180	48	42	M39	2325	2230	48	48	M45	2345	2230	48	62	M56	2445	2300	48	70	M64	
2100	2375	2285	48	42	M39	2440	2335	48	56	M52	-	-	-	-	-	-	-	-	-	-	
2200	2475	2390	52	42	M39	2550	2440	52	56	M52	2555	2440	52	62	M56	-	-	-	-	-	
2400	2685	2600	56	42	M39	2760	2650	56	56	M52	2765	2650	56	62	M56	-	-	-	-	-	

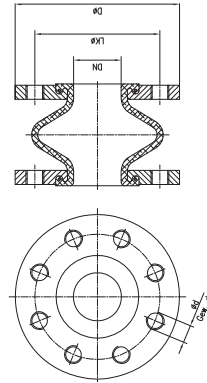

Creating a movement diagram

All combinations of the movement can be taken from this chart.

Maximum movements



max. axial : +30/-45 mm



max. lateral : +/-30 mm

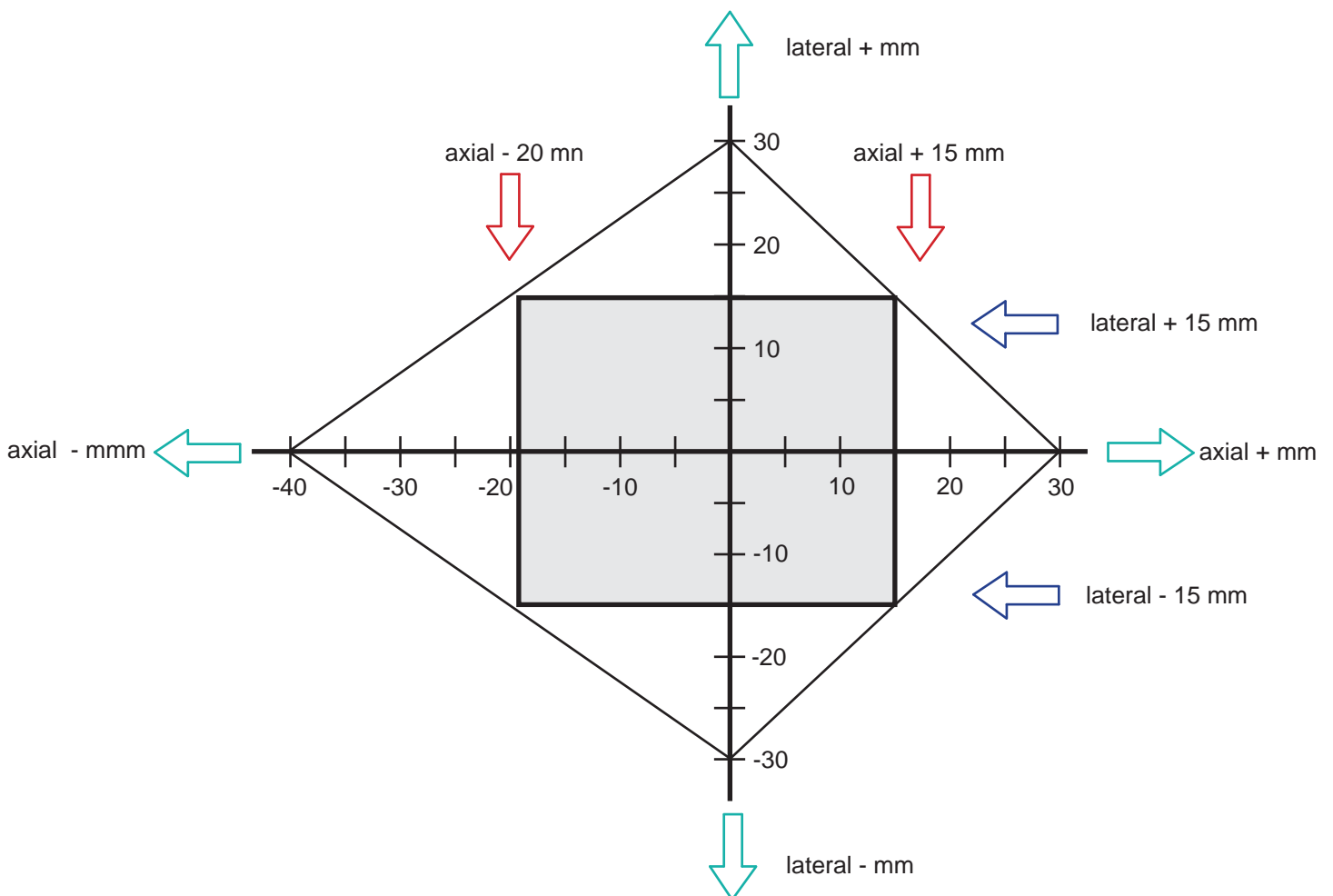

The current movements in combination must fit into the movement diamond as a rectangle.

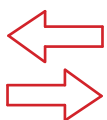

Example: axial -20 mm

lateral +15 mm



lateral max +/- 15 mm