

# NOZZLE FASTENING ASSEMBLING OPTIONS FOR ALL PURPOSES

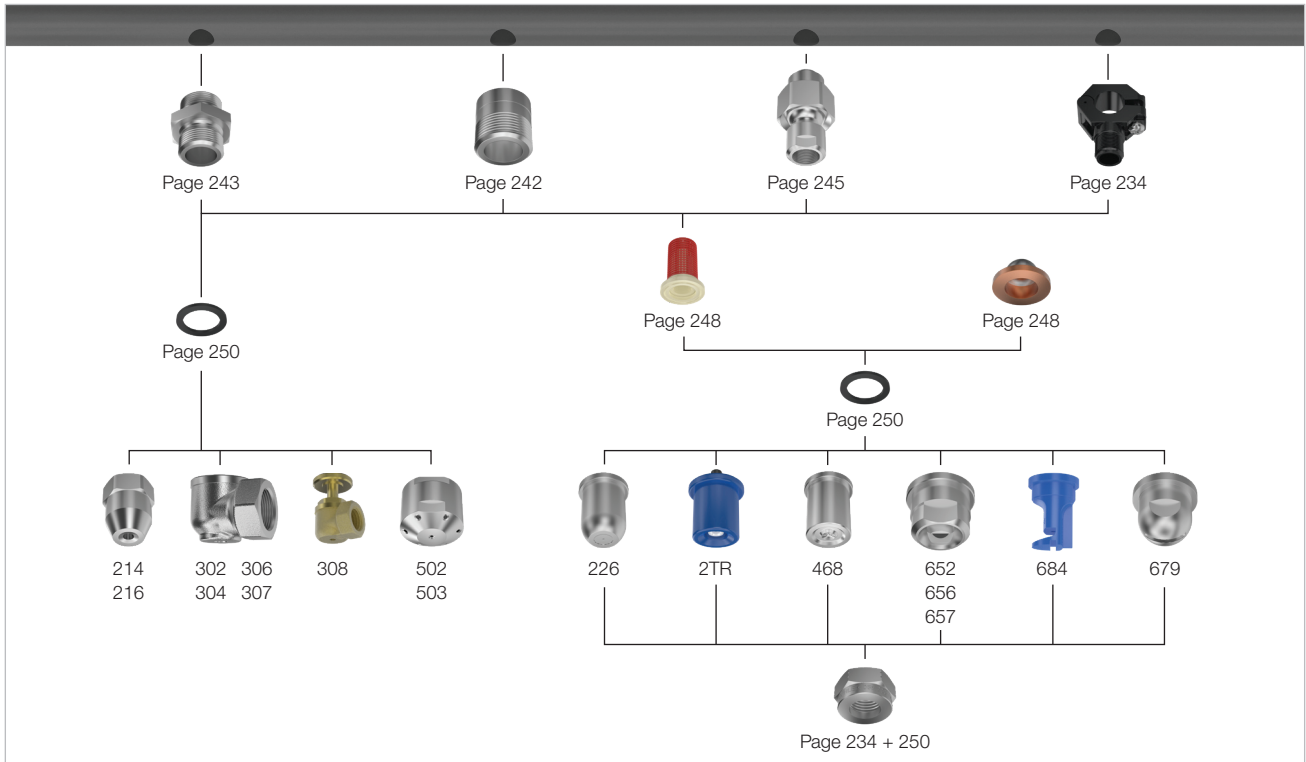

## Assembly accessories for nozzles without thread or with female thread



## Bayonet quick-release system for nozzles without thread or with bayonet connection

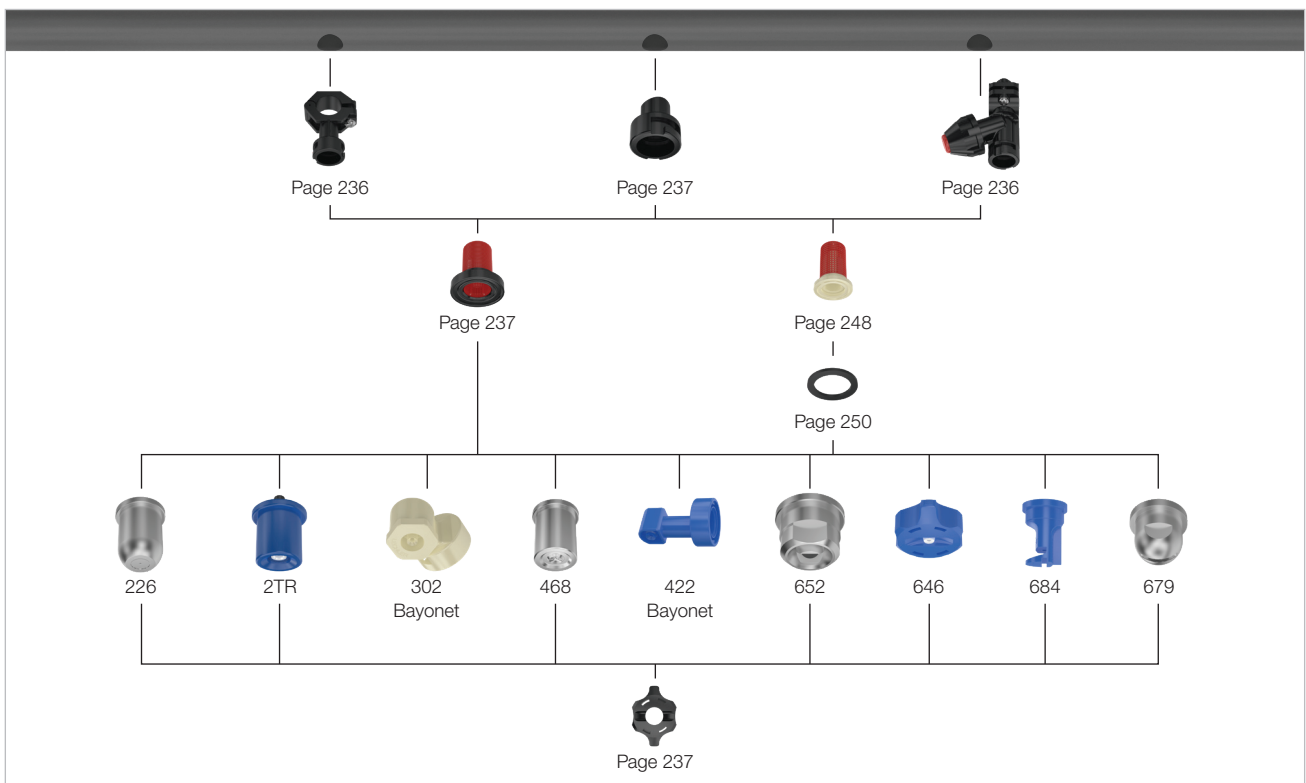

## Bayonet quick-release system with ball joint for nozzles with male thread

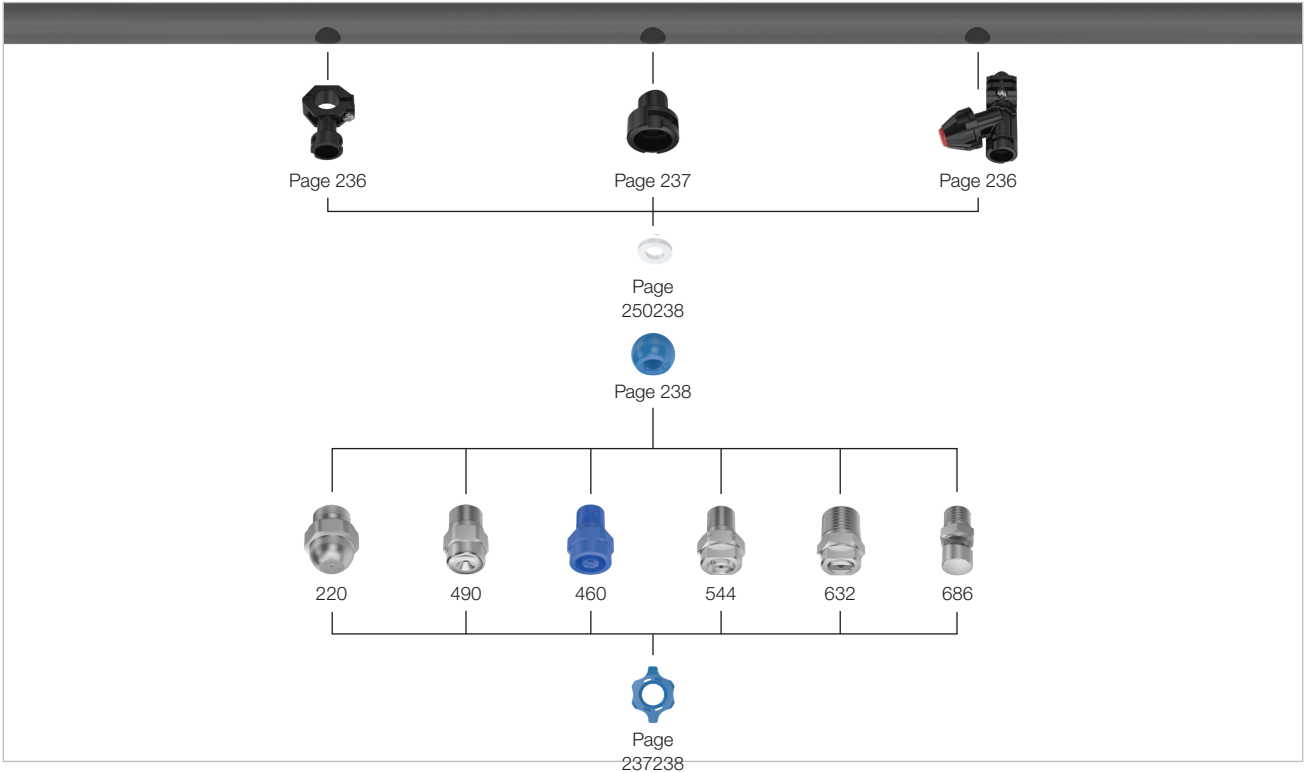

## Assembly accessories for nozzles with male thread

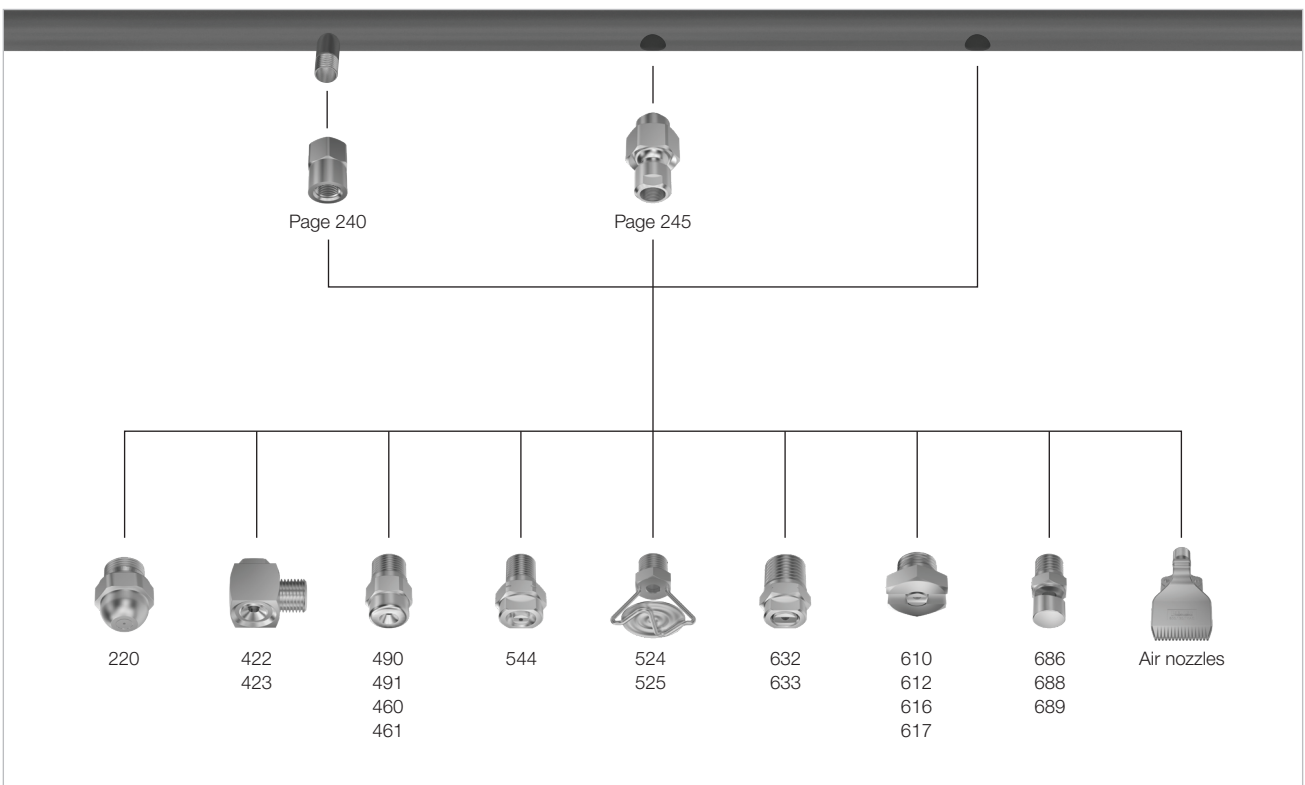



### Assembly accessories for nozzles with dovetail version

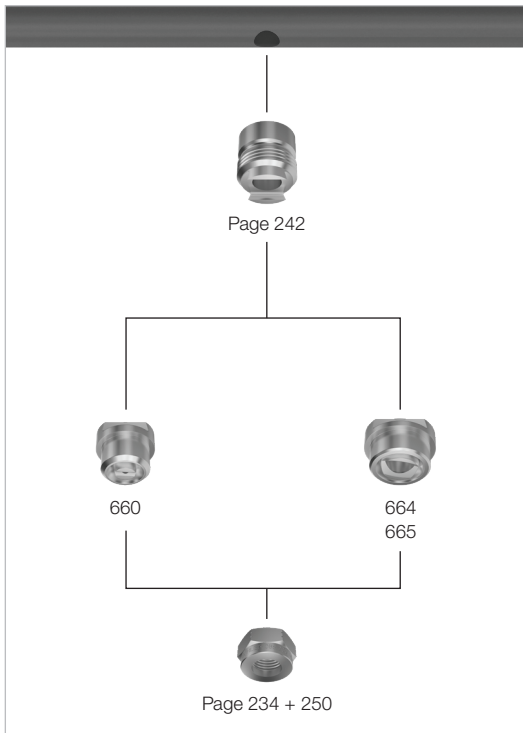

### Assembly accessories for nozzles with integrated ball joint

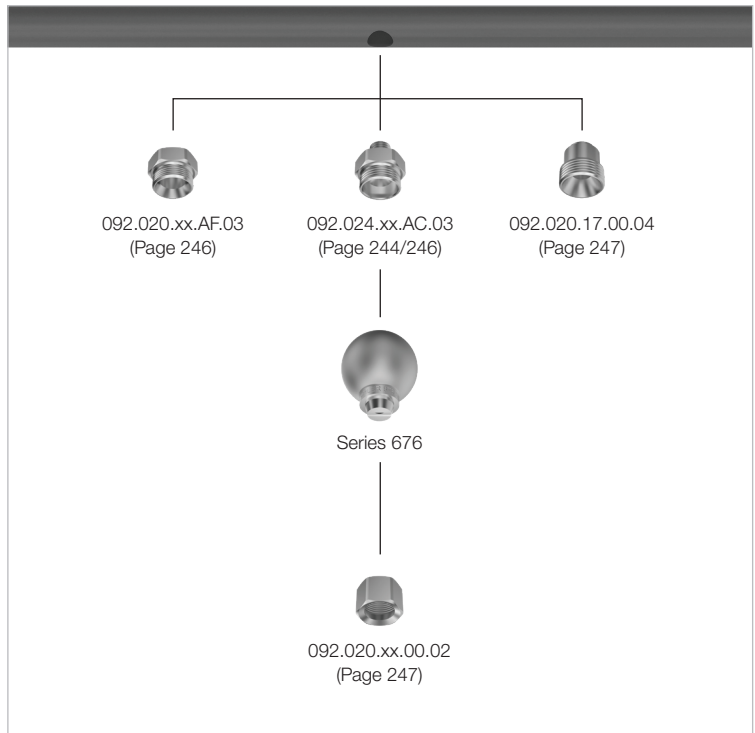

### TWISTLOC quick-release system for nozzles without thread

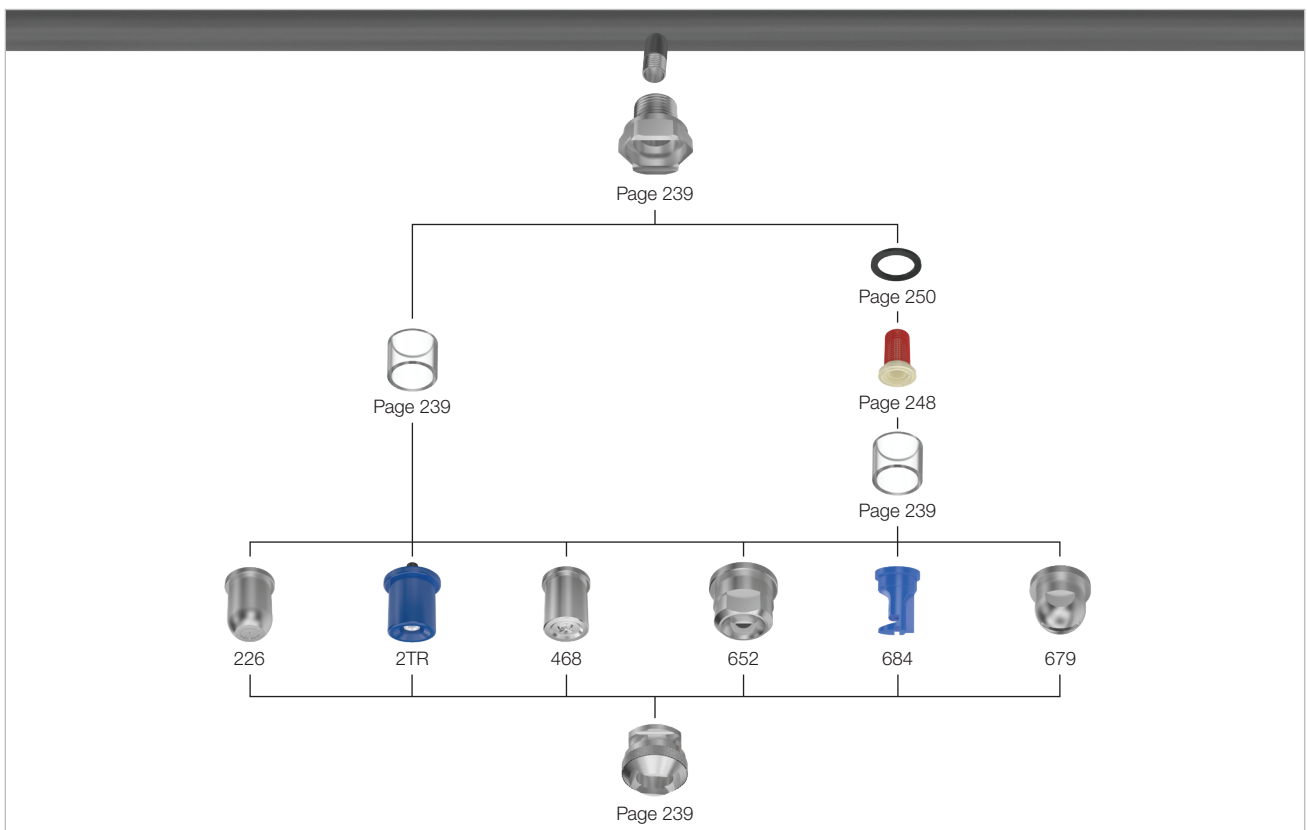

MEMOSPRAY/Easy-Clip combination options

