

ACCESSORIES

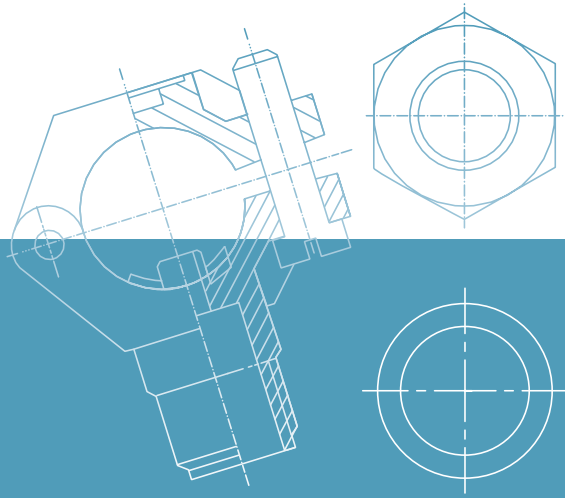

NOZZLE FASTENING ASSEMBLING OPTIONS FOR ALL PURPOSES



Assembly accessories for nozzles without thread or with female thread

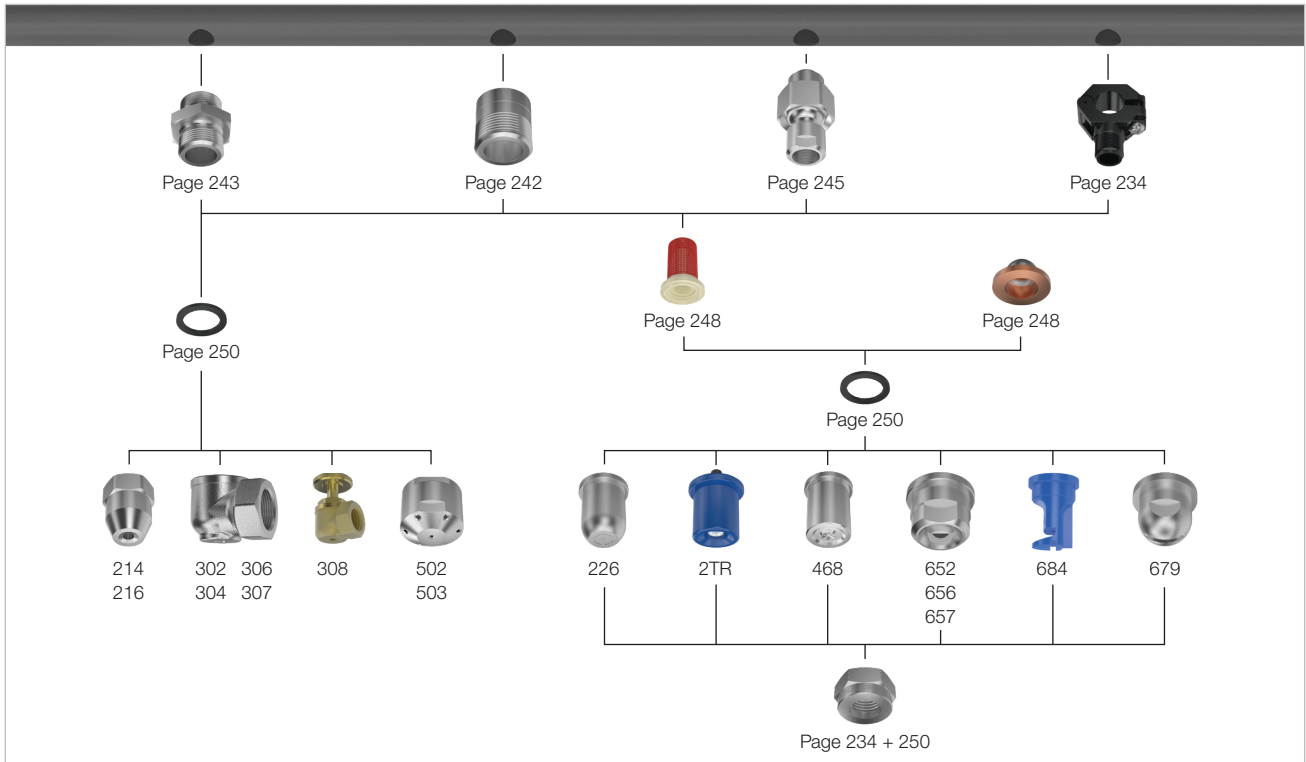

Bayonet quick-release system for nozzles without thread or with bayonet connection

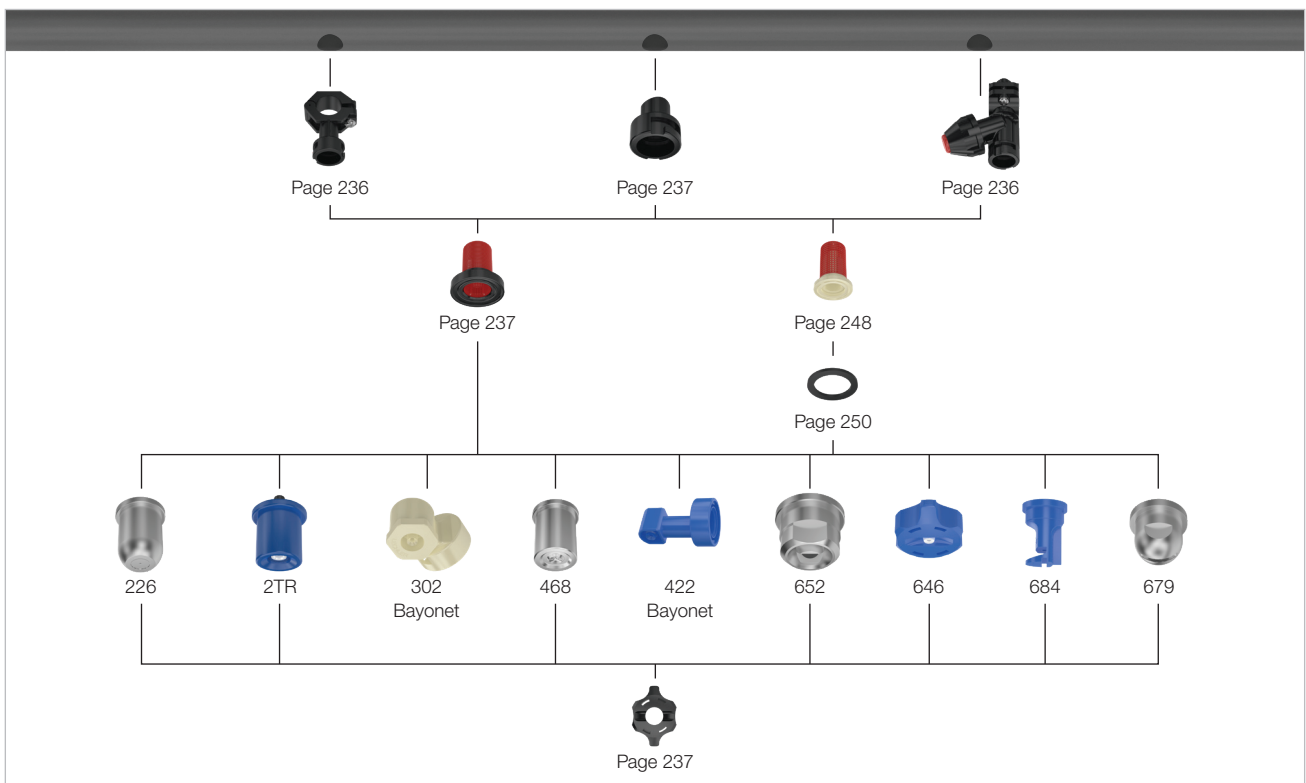

Bayonet quick-release system with ball joint for nozzles with male thread

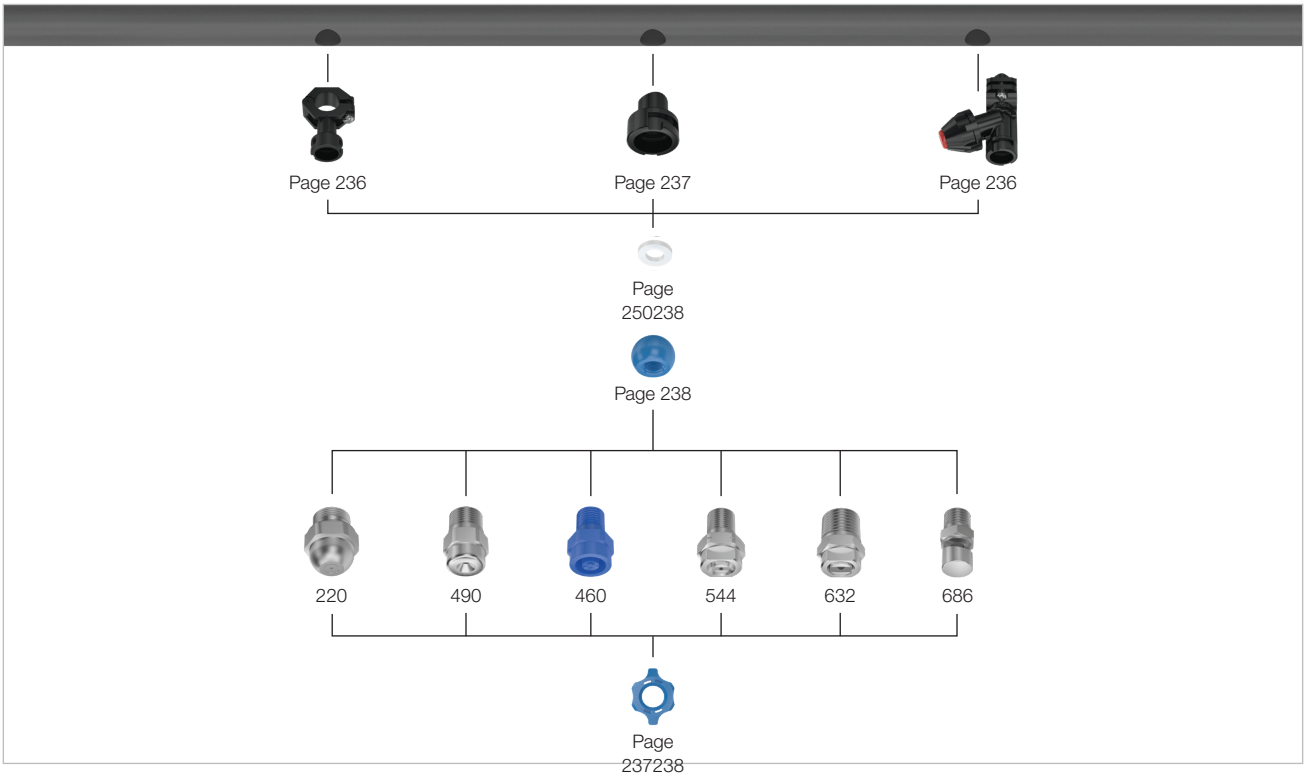

Assembly accessories for nozzles with male thread

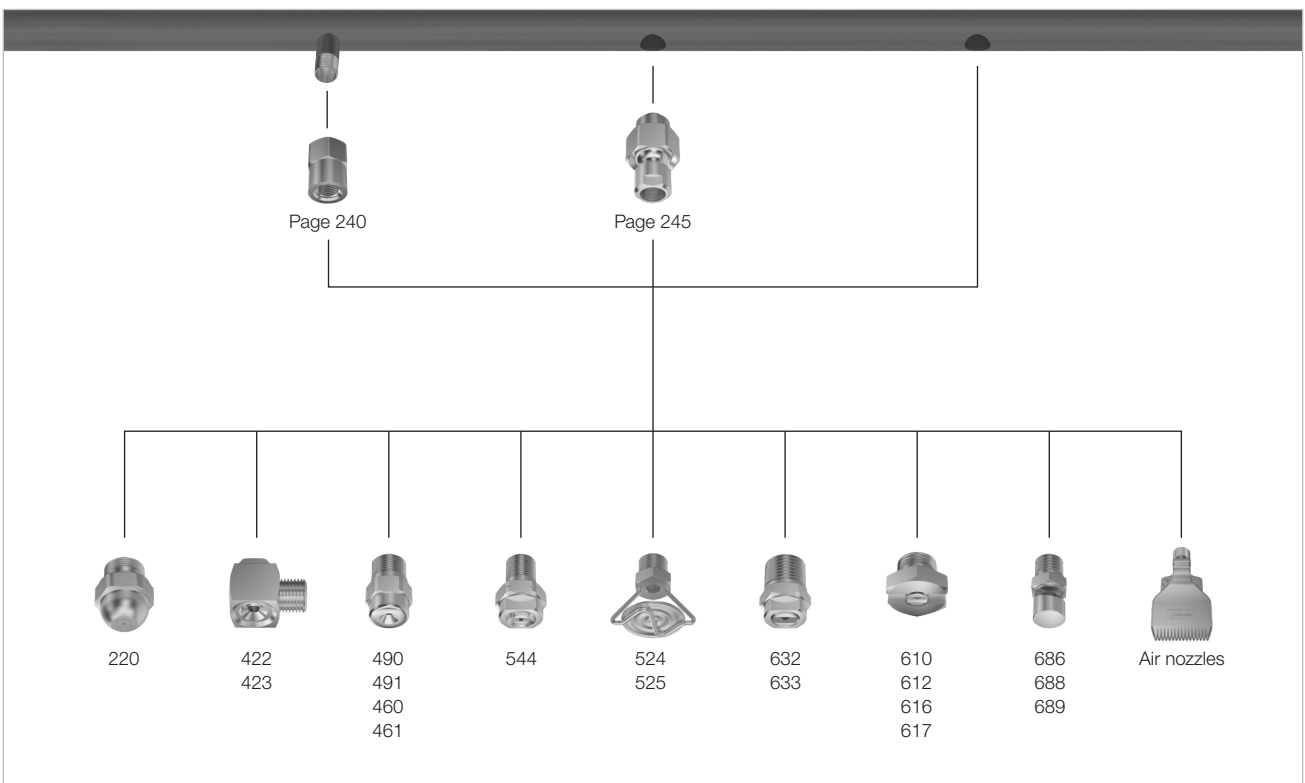



Assembly accessories for nozzles with dovetail version

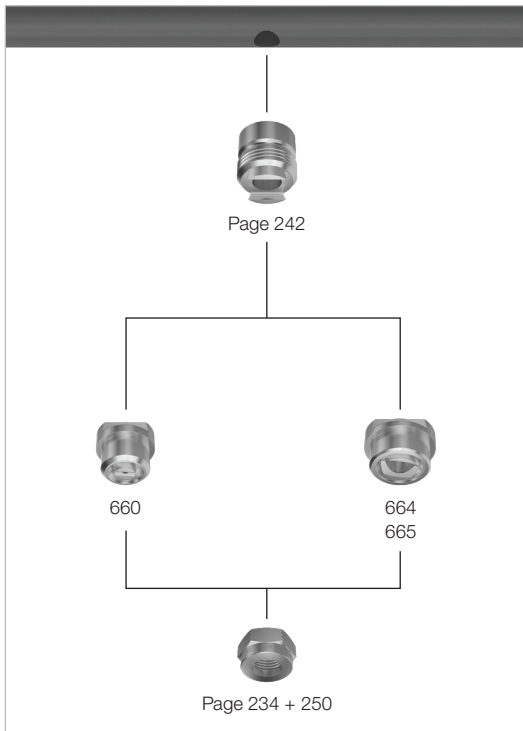

Assembly accessories for nozzles with integrated ball joint

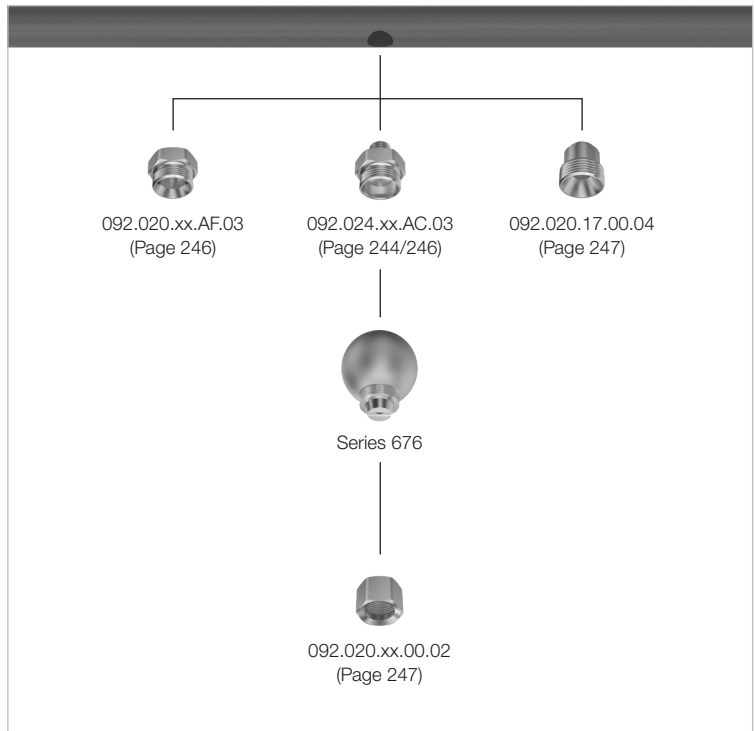

TWISTLOC quick-release system for nozzles without thread

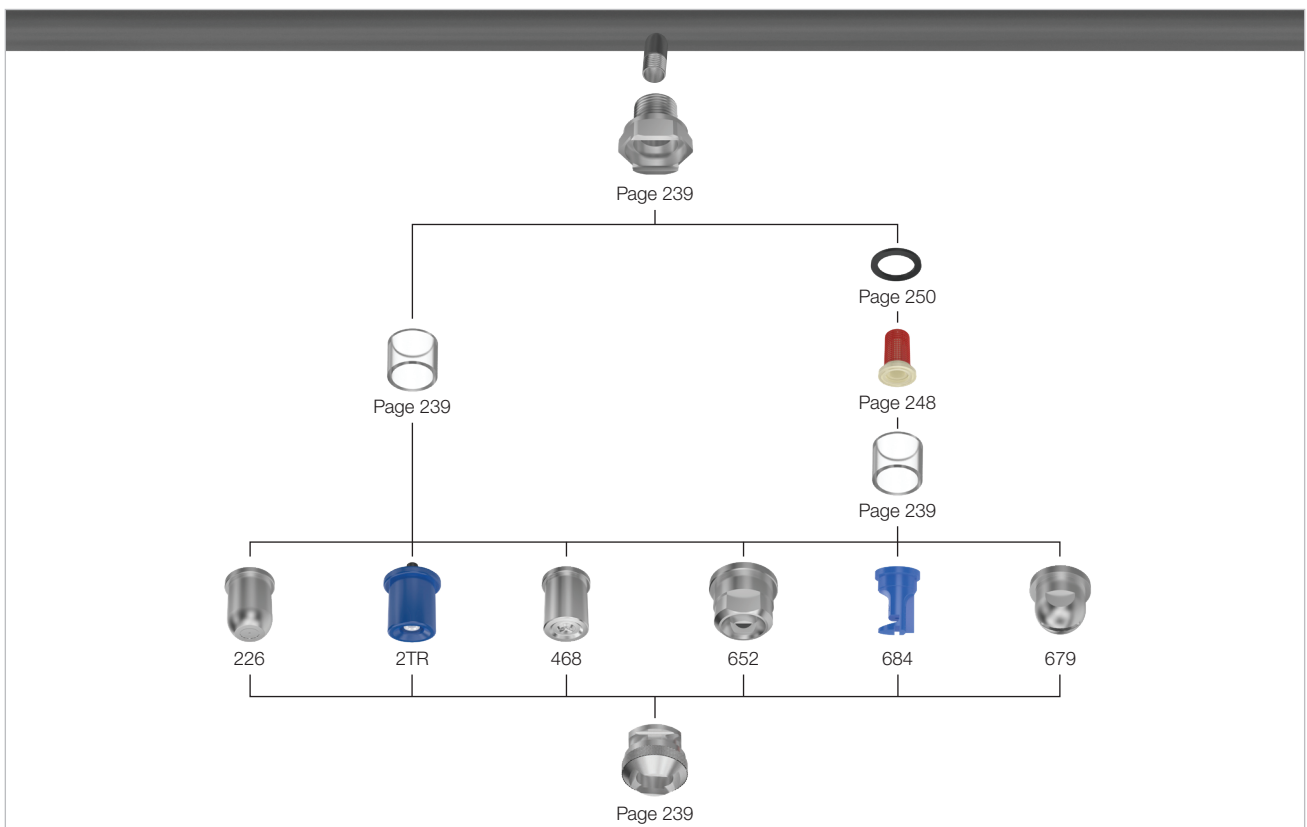

MEMOSPRAY/Easy-Clip combination options

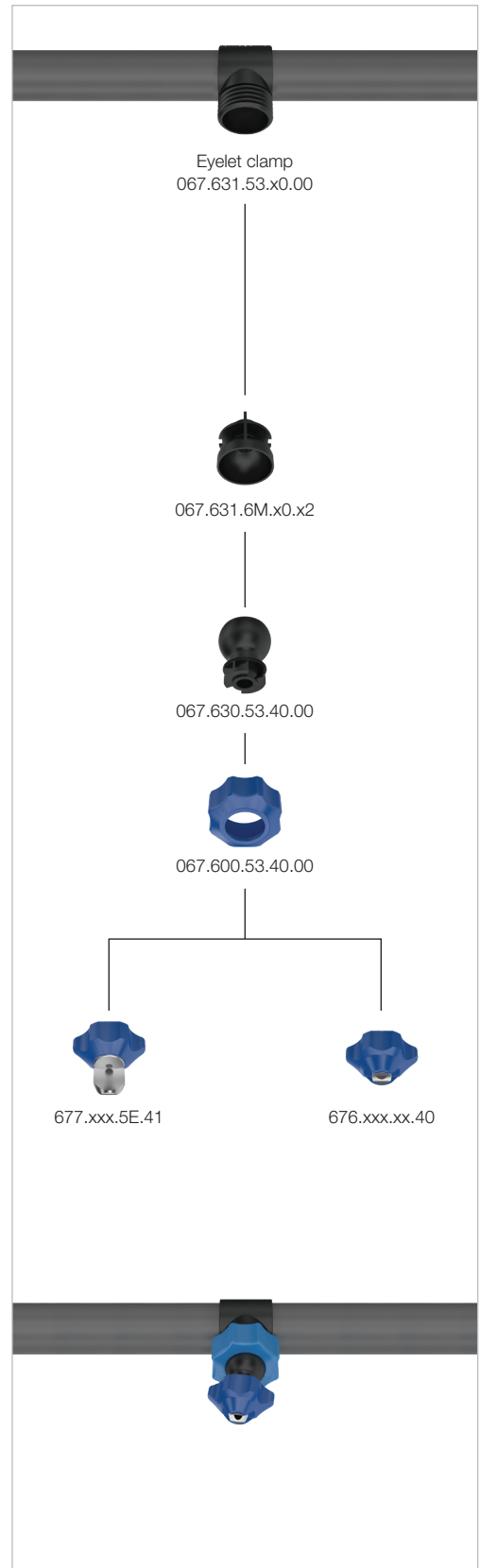
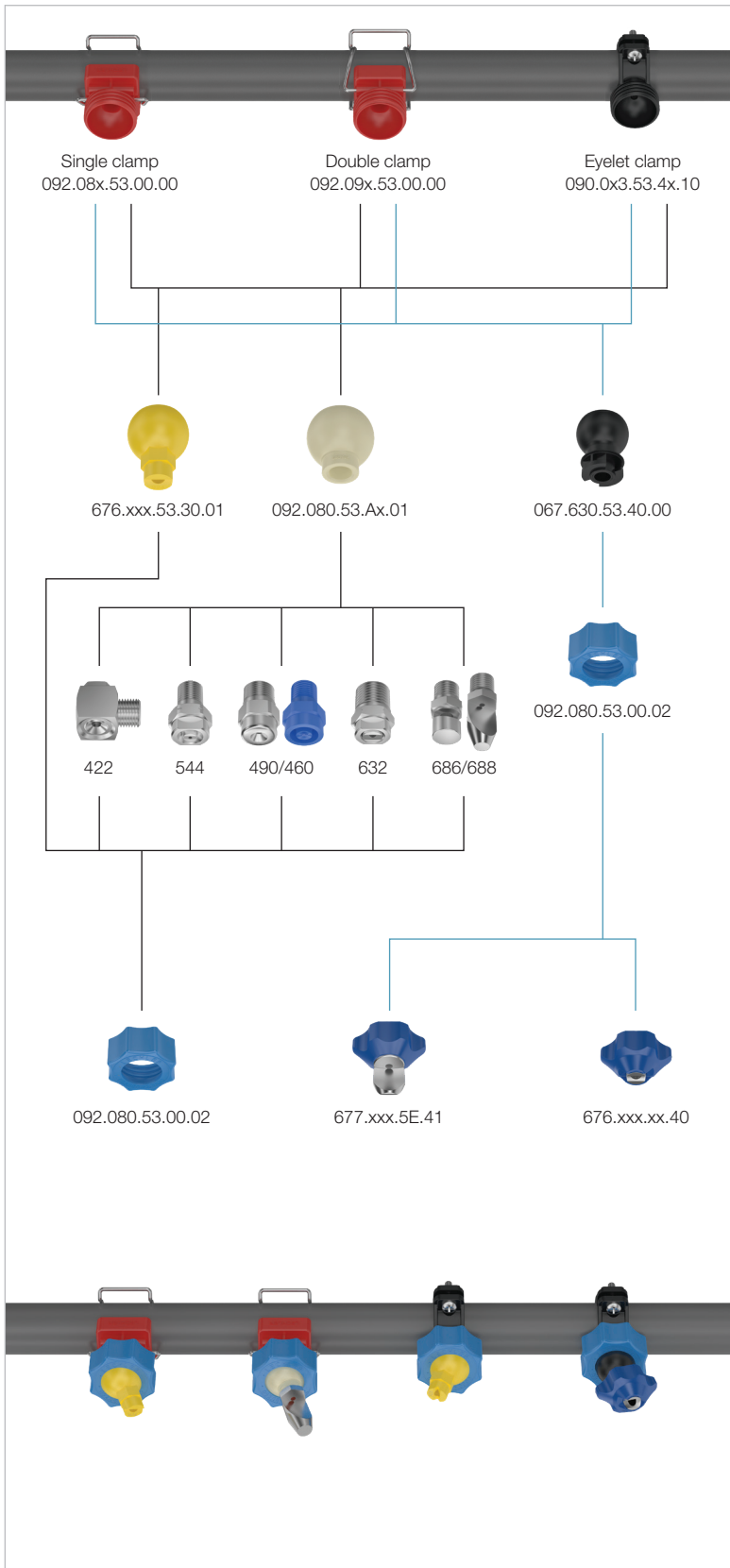

Eyelet clamps with male thread



Eyelet clamps with male thread

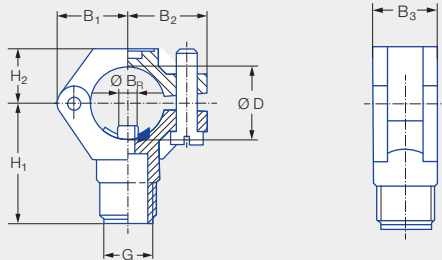

| Series | Ordering no. | | | Screw (material) | G BSPP | Pipe Ø | Dimensions [mm] | | | | | | | Weight [g] (polyamide) | | |
|---|--------------|----------|----------|------------------|---------------------|--------|-----------------|----------------|----------------|----------------|----------------|-------------------------------|------------------|------------------------|-----------|---------|
| | Type | Mat. no. | | | | | B ₁ | B ₂ | B ₃ | H ₁ | H ₂ | Ø B _R ¹ | Ø B ² | | Ø D | |
| | | 51 Black | 53 White | | | | | | | | | | | | | 5E Blue |
| 226/2TR/ 216/302/ 308/350/468/ 652/679/684 | 090.053 | ● | ● | ● | Stainless steel 304 | 3/8 | 3/8" | 19.0 | 22.0 | 18.5 | 34.5 | 14.5 | 6.0 | 6.2-6.4 | 16.5-18.0 | 20.0 |
| | 090.003 | ● | ● | ● | | 3/8 | 1/2" | 21.2 | 23.8 | 18.5 | 36.5 | 16.5 | 6.0 | 6.2-6.4 | 20.0-22.0 | 20.0 |
| | 090.013 | ● | ● | ● | | 3/8 | 3/4" | 24.5 | 26.5 | 22.0 | 39.5 | 17.5 | 7.6 | 7.8-8.0 | 25.0-27.5 | 25.0 |
| | 090.023 | ● | ● | ● | | 3/8 | 1" | 30.0 | 31.0 | 22.0 | 44.0 | 21.0 | 10.6 | 10.8-11.0 | 32.0-34.5 | 32.0 |
| | 090.033 | ● | ● | ● | | 3/8 | 1 1/4" | 34.0 | 35.5 | 25.0 | 48.0 | 25.0 | 12.6 | 12.8-13.0 | 40.0-43.0 | 38.0 |

¹ Ø B_R = spigot diameter.

² Ø B = recommended bore diameter.

Retaining nuts for eyelet clamps

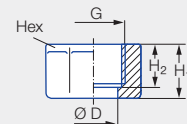
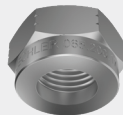

| Series | Ordering no. | | | | | G BSPP | Dimensions [mm] | | | | Weight [g] | |
|---|--------------|----------|-----------------|----|----------|--------|-----------------|----------------|------|------|--------------|------------|
| | Type | Mat. no. | | | | | H ₁ | H ₂ | Ø D | Hex | | |
| | | 16 | 17 ¹ | 30 | 56 Black | | | | | | | 5E Blue |
| 226/2TR/ 468/548/ 652/660/679/ 684 | 065.200 | ● | ● | ● | | 3/8 | 13.0 | 10.0 | 12.8 | 22 | 25.0 (Brass) | |
| | 065.200 | | | | ● | | ● | 14.5 | 11.5 | 12.8 | 22 | 5.0 (PVDF) |

¹ We reserve the right to supply material 316Ti or 316L under material no. 17.

Ordering Type + Material no. = Ordering no.
example: 090.053 + 51 = 090.053.51

Strainers and ball-type non-return valves can be found on Page 248/249.

Eyelet clamps with female thread



Eyelet clamps with female thread

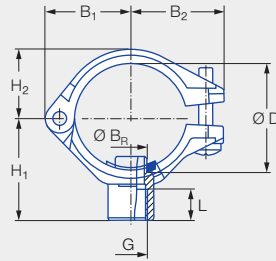

| For all nozzles with | Ordering no. | | | | | | Screw (material) | Pipe Ø | Dimensions [mm] | | | | | | | Weight [g] (polyamide) | | |
|-------------------------------------|--------------|----------|----------|---------|----------|----------|---------------------|--------|-----------------|----------------|----------------|----------------|----------------|------|-------------------------------|------------------------|------------------|------|
| | Type | Mat. no. | | | Code | | | | B ₁ | B ₂ | B ₃ | H ₁ | H ₂ | L | Ø B _R ¹ | | Ø B ² | Ø D |
| | | 51 Black | 53 White | 5E Blue | 1/8 BSPP | 1/4 BSPP | | | | | | | | | | | | |
| Male thread 1/8 BSPP 1/4 BSPP | 090.100 | ● | ● | ● | AB | AD | Stainless steel 316 | 3/8" | 20.0 | 23.0 | 18.5 | 28.0 | 14.0 | 12.0 | 6.0 | 6.2-6.4 | 16.5-18.0 | 18.0 |
| | 090.110 | ● | ● | ● | AB | AD | | 1/2" | 22.0 | 25.0 | 18.5 | 31.0 | 16.0 | 12.0 | 6.0 | 6.2-6.4 | 20.0-22.0 | 19.0 |
| | 090.120 | ● | ● | ● | AB | AD | | 3/4" | 25.0 | 28.0 | 22.0 | 33.0 | 19.0 | 12.0 | 7.6 | 7.8-8.0 | 25.0-27.5 | 24.0 |
| | 090.130 | ● | ● | ● | AB | AD | | 1" | 30.0 | 33.0 | 22.0 | 36.0 | 23.0 | 12.0 | 10.6 | 10.8-11.0 | 32.0-34.5 | 34.0 |
| | 090.140 | ● | ● | ● | AB | AD | | 1 1/4" | 34.0 | 37.0 | 25.0 | 40.0 | 28.0 | 12.0 | 12.6 | 12.8-13.0 | 40.0-43.0 | 39.0 |

¹ Ø B_R = spigot diameter.

² Ø B = recommended bore diameter.

Ordering Type + Material no. + Code = Ordering no.
 example: 090.100 + 51 + AB = 090.100.51.AB

Eyelet clamps with bayonet connection

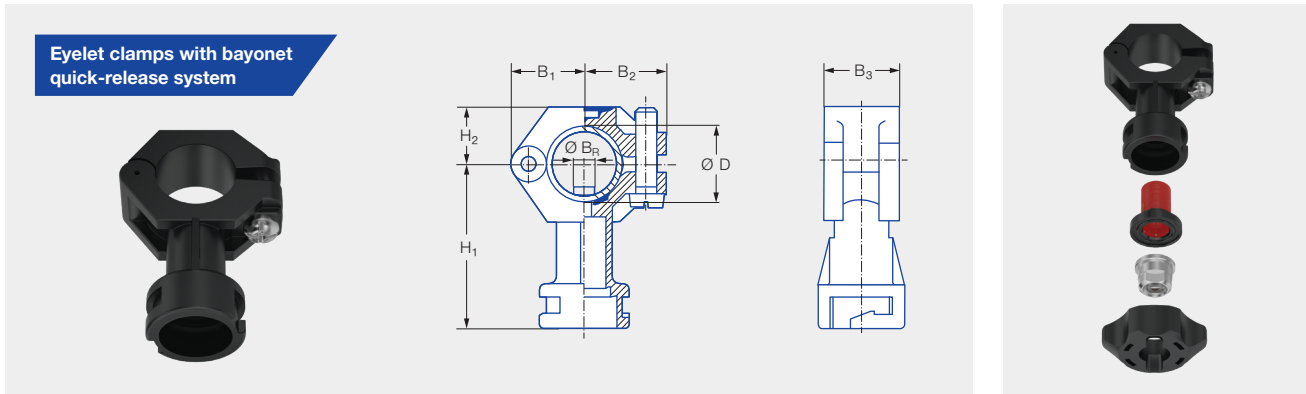

| Series | Ordering no. | | | | Screw (material) | Pipe Ø | Dimensions [mm] | | | | | | | Weight [g] (Polyamide) | | |
|---|--------------|--------------------|------------------------|--------------|------------------|---------------------|-----------------|----------------|----------------|----------------|----------------|----------------|-------------------------------|------------------------|------------------|------|
| | Type | Mat. no. | | | | | Code | B ₁ | B ₂ | B ₃ | H ₁ | H ₂ | Ø B _R ¹ | | Ø B ² | Ø D |
| | | 51 Black Polyamide | 53 White Polypropylene | 5E Blue PVDF | | | | | | | | | | | | |
| 226/2TR/ 302 bayonet/ 422 bayonet/ 468/652/646/ 684/679 | 090.003 | ● | ● | ● | KA | Stainless steel 304 | 1/2" | 21.2 | 23.8 | 18.5 | 49.5 | 16.5 | 6.0 | 6.2–6.4 | 20.0–22.0 | 22.0 |
| | 090.013 | ● | ● | ● | KA | | 3/4" | 24.5 | 26.5 | 22.0 | 52.5 | 17.5 | 7.6 | 7.8–8.0 | 25.0–27.5 | 26.0 |
| | 090.023 | ● | ● | ● | KA | | 1" | 30.0 | 31.0 | 22.0 | 57.0 | 21.0 | 10.6 | 10.8–11.0 | 32.0–34.5 | 32.0 |

¹ Ø B_R = spigot diameter.
² Ø B = recommended bore diameter.

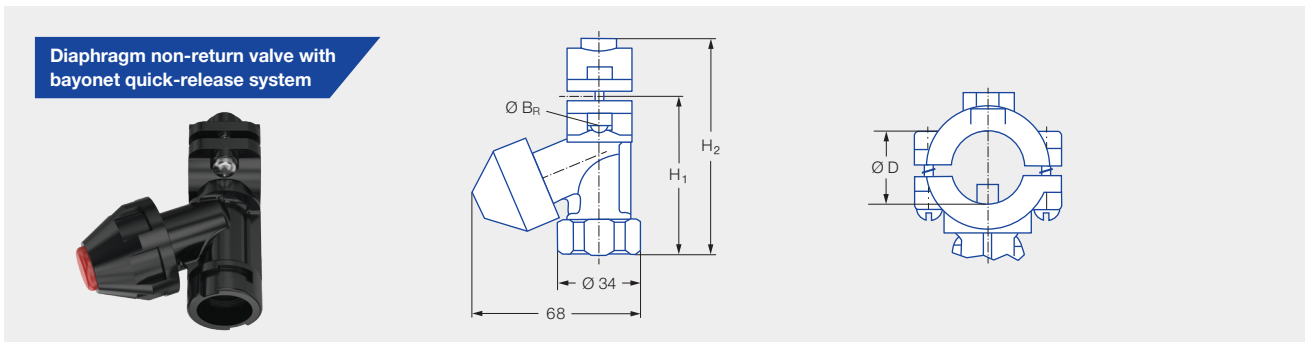

| Series | Ordering no. | | | Screw (material) | Pipe Ø | Ø D [mm] | Pressure [bar] | | Dimensions [mm] | | | | Weight [g] | |
|---|--------------|----------|-----|------------------|---------------------|----------|----------------|------------------|------------------|----------------|----------------|-------------------------------|------------|------------------|
| | Type | Mat. no. | | | | | Code | Opening pressure | Closing pressure | H ₁ | H ₂ | Ø B _R ¹ | | Ø B ² |
| | | 56 Black | POM | | | | | | | | | | | |
| 226/2TR/ 302 bayonet/ 422 bayonet/ 468/652/646/ 684/679 | 065.272 | ● | | KH | Stainless steel 303 | 1/2" | 20.0–22.0 | 0.8 | 0.6 | 59.0 | 84.0 | 6.0 | 6.2–6.4 | 48.0 |
| | 065.272 | ● | | KL | | 3/4" | 25.0–27.5 | 0.8 | 0.6 | 66.0 | 90.0 | 9.6 | 9.8–10.0 | 53.0 |

¹ Ø B_R = spigot diameter.
² Ø B = recommended bore diameter.

| Material | Max. temperature [°C] | Max. pressure [bar] |
|-------------------|-----------------------|---------------------|
| PA, PP, PVDF, POM | 65 | 10 |
| PA, PP, PVDF, POM | 80 | 8 |
| PVDF | 100 | 4 |

Notice: Please consider the material combination when using bayonet eyelet clamps with bayonet quick-release system nuts. The nuts may be difficult to turn when using different materials.

Accessories for bayonet system



Bayonet welded nipple

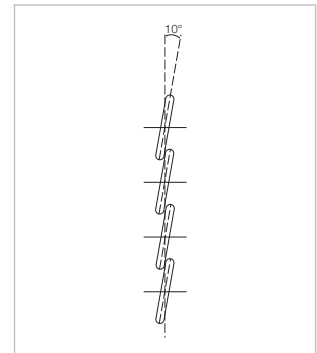
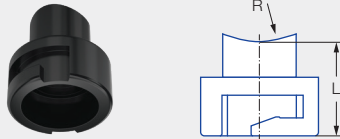

Twist angle to the right in relation to the pipe axis. Twist angle 10°. Other twist angles available on request.

| Series | Ordering no. | | | Dimensions [mm] | | Weight [g] |
|---|-------------------------------|----------|---------------|-----------------|------|------------|
| | Type | Mat. no. | | L | R | |
| | | 50 | 53 | | | |
| 226/2TR/302 bayonet/ 422 bayonet/468/ 652/646/684/679 | 095.016.xx.08.05 ¹ | PVC | Polypropylene | 25.0 | 16.0 | 10.0 |

¹ Replace "xx" with the desired material no.

Strainer with gasket

Suitable for bayonet quick-release system nuts 065.202

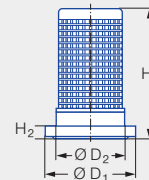

| Performance size | Ordering no. | | Colour | Dimensions [mm] | | | | | Weight [g] |
|------------------|--------------|----------------|--------|-----------------|----------------|----------------|------------------|------------------|------------|
| | Type | Mat. no. | | Mesh size | H ₁ | H ₂ | Ø D ₁ | Ø D ₂ | |
| | | 7J | | | | | | | |
| xxx.32x-xxx.44x | 065.268 | POM/Santoprene | Blue | 0.25 | 19.20 | 3.00 | 18.00 | 12.00 | 2.00 |
| xxx.48x-xxx.56x | 065.269 | POM/Santoprene | Red | 0.65 | 19.20 | 3.00 | 18.00 | 12.00 | 2.00 |

Bayonet quick-release system nuts

Incl. gasket 065.242.73 (material: Rubber)

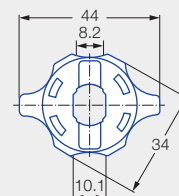

| Series | Ordering no. | | | Colour | Weight [g] |
|---------|---------------|----------|---------------|--------|------------|
| | Type | Mat. no. | | | |
| | | POM | Polypropylene | | |
| 652/679 | 065.202.56.00 | | | Red | 10.0 |
| | 065.202.53.00 | | | Grey | 10.0 |
| | 065.202.5E.00 | | | Blue | 10.0 |

Bayonet quick-release system nuts

Incl. gasket 065.242.73 (material: Rubber)

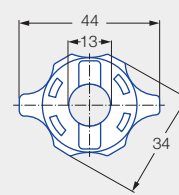

| Series | Ordering no. | | Colour | Weight [g] |
|---------------------|---------------|----------|--------|------------|
| | Type | Mat. no. | | |
| | | POM | | |
| 226/2TR/ 468/684 | 065.202.56.11 | | Black | 10.0 |
| | 065.202.53.11 | | Grey | 10.0 |

Notice: Please consider the material combination when using bayonet eyelet clamps with bayonet quick-release system nuts. The nuts may be difficult to turn when using different materials.



Ball joints for bayonet quick-release system

Ball joint system for nozzles with 1/8" and 1/4" male thread.

Ball joint for eyelet clamps with bayonet quick-release system

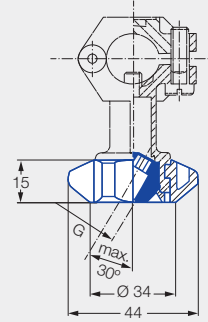

| For all nozzles with 1/8" or 1/4" male thread | Ordering no. | | | | Colour | Weight [g] |
|---|----------------|-----------|-----------|-----------|--------|------------|
| | Type | Mat. no. | Code | | | |
| | | PVDF | 1/8 BSPP | 1/4 BSPP | | |
| Ball joint | 092.150 | 5E | AB | AD | Blue | 5.0 |

Bayonet quick-release system nut for ball joint

Incl. O-ring
Ordering no. 095.015.7C.04.16.0
(material: 72 NBR 872)

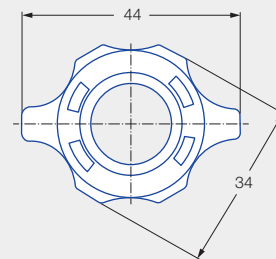

| For all nozzles with 1/8" or 1/4" male thread | Ordering no. | | | Colour | Weight [g] |
|---|----------------------|----------|--|--------|------------|
| | Type | Mat. no. | | | |
| | | PVDF | | | |
| Quick-release system nut | 092.150.5E.00 | ● | | Blue | 28.0 |

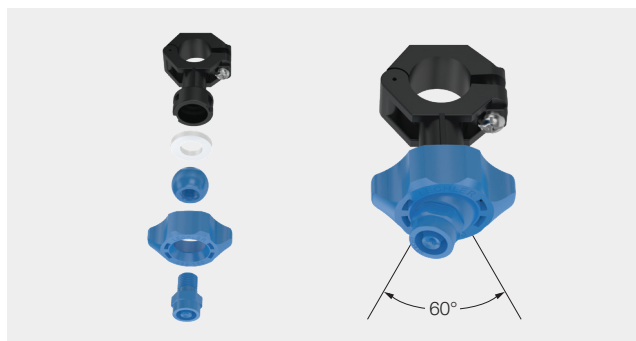

| Max. temperature [°C] | Max. pressure [bar] |
|-----------------------|---------------------|
| 65 | 10 |
| 80 | 8 |
| 100 | 4 |

Ordering Type + Material no. + Code = Ordering no.
example: 092.150 + 5E + AB = 092.150.5E.AB

» TWISTLOC

Quick-change nozzle system



Lechler TWISTLOC, nozzle changing in less than no time.

Save time and money with the quick-change nozzle system.

- **Quick:**
It takes just one twist to install or remove the nozzle.
- **Easy:**
Can be installed without tools – even in difficult-to-access locations and in bad lighting conditions.
- **Safe:**
Installation errors are avoided, as the nozzles are always set to the correct direction.
- **Max. pressure:**
15 bar.

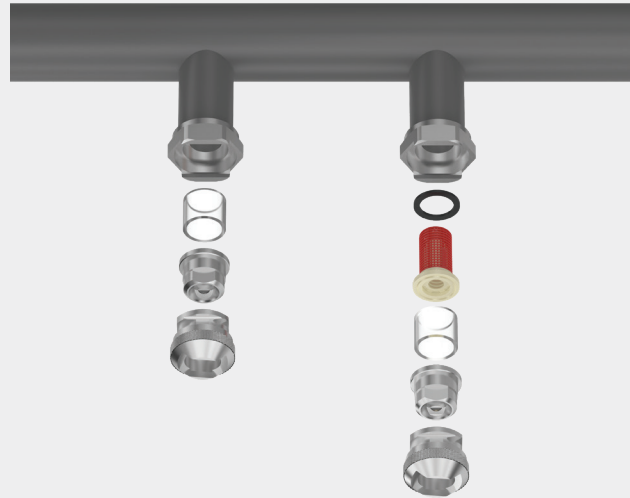

| System components | | Ordering no. | | | | | | | Inner Ø D [mm] | Weight [g] | |
|--|--|--------------|---------------------------------|---------------------------------|------------|-------------|-------------|-------------|----------------------|---------------|---------------------------|
| | | Type | Mat. no. | | | | Code | | | | |
| | | | 1C Stainless steel 304 | 16 Stainless steel 303 | 5E PVDF | 7A Viton | 1/4 BSPT | 3/8 BSPT | | | Welded connec- tion |
| Threaded nipple | | 092.102 | • | | | | CC | | 8.0 | 25.0 | |
| | | 092.102 | • | | | | | CE | | 11.6 | 25.0 |
| | | 092.102 | | | • | | | | CE | | 8.0 |
| Welded nipple | | 092.104 | • | | | | | 00 | | 11.6 | 45.0 |
| Gasket for material 304 SS and 303 SS | | 092.113 | | | | • | | | | – | 1.0 |
| Gasket for material PVDF | | 092.115 | | | | • | | | | – | 1.0 |
| Gasket, incl. rubber gasket ring for use with non-return valves or strainers | | 092.116 | | | | • | | | | – | 2.0 |
| Gasket, incl. rubber gasket ring for use with non-return valves or strainers, for PVDF material | | 092.114 | | | | • | | | | – | 2.0 |
| Quick-release system For nozzle series 652/679 | | 092.106 | • | • | | | | | | – | 20.0 (stainless steel) |
| Quick-release system For nozzle series 226/468/684 | | 092.108 | • | • | | | | | | – | 20.0 (stainless steel) |

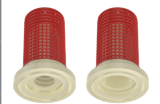

Non-return valves, strainers
For installation in nipples with inner Ø 11.6 mm (see Page 248/249).

Ordering Type + Material no. + Code = Ordering no.
example: 092.102 + 16 + CC = 092.102.16.CC



Sockets

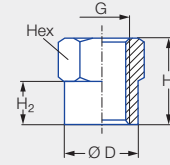
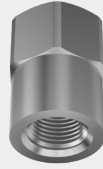

| For all nozzles with | Ordering no. | | | | G BSPP | Dimensions [mm] | | | | Weight [g] (Brass) | |
|----------------------|--------------|----------|----|----|--------|-----------------|----------------|------|------|--------------------|-------|
| | Type | Mat. no. | | | | H ₁ | H ₂ | Ø D | Hex | | |
| | | 1Y | 17 | 30 | | | | | | | 53 |
| 1/8" male thread | 040.270 | ● | | ● | | 1/8 | 20.0 | 10.0 | 13.8 | 14 | 20.0 |
| 1/4" male thread | 061.220 | ● | | ● | | 1/4 | 20.0 | 10.0 | 16.8 | 17 | 20.0 |
| 3/8" male thread | 040.271 | | ● | ● | | 3/8 | 20.0 | 10.0 | 21.8 | 22 | 25.0 |
| | 040.271 | | | | ● | 3/8 | 20.0 | 11.0 | 25.0 | 22 | 25.0 |
| 1/2" male thread | 040.272 | | ● | ● | | 1/2 | 30.0 | 15.0 | 26.5 | 27 | 70.0 |
| 3/4" male thread | 061.620 | | ● | ● | | 3/4 | 40.0 | 20.0 | 31.5 | 32 | 108.0 |

Notice: Sockets are also suitable for welding.

Sockets with radius

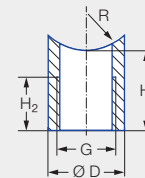

| For all nozzles with | Ordering no. | | G BSPP | Dimensions [mm] | | | Weight [g] |
|----------------------|----------------------------|----------|--------|-----------------|----------------|------|------------|
| | Type | Mat. no. | | H ₁ | H ₂ | Ø D | |
| | | 1Y | | | | | |
| 1/4" male thread | 040.228.1Y.yy ¹ | ● | 1/4 | 18.0 | 12.0 | 17.0 | 16.0 |

¹ Replace "yy" with the desired radius R (R = 10/13/16/20/25 or 31 mm).

Ordering Type + Material no. = Ordering no.
 example: 040.270 + 1Y = 040.270.1Y

Sockets

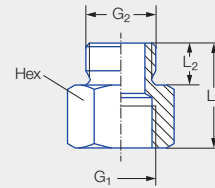

| Connection components | Ordering no. | | | G ₁ BSPP | G ₂ BSPP | Dimensions [mm] | | | Weight [g] (Brass) |
|-----------------------|----------------|-----------------------|-------|------------------------|------------------------|-------------------|----------------|-----|--------------------|
| | Type | Mat. no. | | | | L ₁ | L ₂ | Hex | |
| | | 17 | 30 | | | | | | |
| | | Stainless steel 316Ti | Brass | | | | | | |
| 1/8" to 3/8" | 040.211 | ● | ● | 1/8 | 3/8 | 20.0 | 10.0 | 22 | 40.0 |
| 1/4" to 3/8" short | 065.221 | ● | ● | 1/4 | 3/8 | 23.0 | 10.0 | 22 | 40.0 |
| 1/4" to 3/8" long | 065.228 | ● | ● | 1/4 | 3/8 | 36.0 ¹ | 14.0 | 19 | 45.0 |
| 3/8" to 3/8" | 065.220 | ● | ● | 3/8 | 3/8 | 25.0 | 10.0 | 22 | 40.0 |
| 3/4" to 3/4" | 065.620 | ● | ● | 3/4 | 3/4 | 35.0 | 14.0 | 32 | 280.0 |

¹ Mounting of nozzle filters and ball-type non-return valves possible (see Page 248/249).

Reduction socket

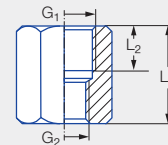
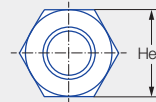
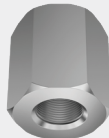

| Connection components | Ordering no. | | | G ₁ BSPP | G ₂ BSPP | Dimensions [mm] | | | Weight [g] |
|-----------------------|-------------------------|----------------------|-------|------------------------|------------------------|-----------------|----------------|-----|------------|
| | Type | Mat. no. | | | | L ₁ | L ₂ | Hex | |
| | | 1Y | 30 | | | | | | |
| | | Stainless steel 316L | Brass | | | | | | |
| 3/8" to 1/4" | 095.019.30.00.23 | | ● | 3/8 | 1/4 | 26.0 | 12.0 | 22 | 55.0 |

Ordering Type + Material no. = Ordering no.
example: 040.211 + 17 = 040.211.17



Welded nipple with dovetail guide

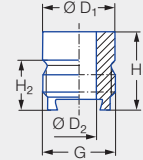

| Series | Ordering no. | | | | G BSPP | Dimensions [mm] | | | | Weight [g] |
|---------|----------------|----------|-----------------------|--|-----------|-----------------|----------------|------------------|------------------|------------|
| | Type | Mat. no. | | | | H ₁ | H ₂ | Ø D ₁ | Ø D ₂ | |
| | | 17 | Stainless steel 316Ti | | | | | | | |
| 660 | 066.011 | ● | | | 3/8 | 18.0 | 11.5 | 16.5 | 8.0 | 21.0 |
| 664/665 | 066.410 | ● | | | 3/4 | 27.0 | 15.5 | 28.0 | 14.0 | 65.0 |

Welded nipple

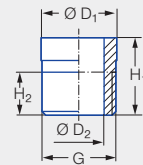

| Series | Ordering no. | | | | | G BSPP | Dimensions [mm] | | | | Weight [g] (Brass) |
|---|----------------|----------|----|----|----|-----------|-----------------|----------------|------------------|------------------|-----------------------|
| | Type | Mat. no. | | | | | H ₁ | H ₂ | Ø D ₁ | Ø D ₂ | |
| | | 02 | 17 | 30 | 53 | | | | | | |
| 226/216/2TR/302/308/350/ 468/652/684/548/679 | 065.210 | ● | ● | ● | ● | 3/8 | 18.0 | 10.0 | 17.2 | 11.6 | 20.0 |
| 306/307/502/ 503/656/657 | 065.610 | ● | ● | | ● | 3/4 | 27.0 | 14.0 | 28.0 | 18.0 | 61.0 |

Ordering Type + Material no. = Ordering no.
example: 066.011 + 17 = 066.011.17

Welded nipple with radius

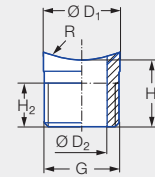

| Series | Ordering no. | | G BSPP | Dimensions [mm] | | | | Weight [g] |
|---|----------------------------------|---|-----------|--------------------|----------------|------------------|------------------|---------------|
| | Type | Mat. no. 17 Stainless steel 316Ti | | H ₁ | H ₂ | Ø D ₁ | Ø D ₂ | |
| 226/216/2TR/302/308/350/ 468/652/684/548/679 | 065.217.17.yy¹ | ● | 3/8 A | 15.0 | 10.0 | 17.2 | 11.5 | 20.0 |
| 306/307/502/503/656/657 | 065.612.17.yy¹ | ● | 3/4 A | 23.0 | 14.0 | 28.0 | 18.0 | 61.0 |

¹ Replace "yy" with the desired radius R (R = 10/13/16/20/25 or 31 mm).

Double nipple

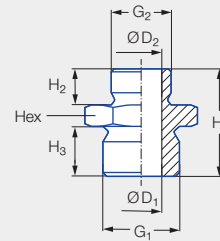
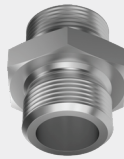

| Series | Ordering no. | | | G ₁ BSPP | G ₂ BSPP | Dimensions [mm] | | | | | | Weight [g] (Brass) |
|---|----------------------------------|--|--------------------|------------------------|------------------------|--------------------|----------------|----------------|------------------|------------------|-----|--------------------------|
| | Type | Mat. no. | | | | H ₁ | H ₂ | H ₃ | Ø D ₁ | Ø D ₂ | Hex | |
| | | 17 Stainless steel 316Ti | 30 Brass | | | | | | | | | |
| 226/216/2TR/ 302/308/350/ 468/652/684/ 548/679 | 065.215¹ | ● | ● | 3/8 | 1/4 | 25.0 | 10.0 | 10.0 | 10.0 | 7.0 | 22 | 30.0 |
| | 065.215.xx.02² | ● | ● | 3/8 | 1/4 | 35.0 | 10.0 | 10.0 | 11.6 | 7.0 | 22 | 32.0 |
| | 065.211 | ● | ● | 3/8 | 3/8 | 25.0 | 10.0 | 10.0 | 11.5 | – | 22 | 25.0 |
| | 065.211.xx.04² | ● | ● | 3/8 | 1/2 | 30.0 | 10.0 | 14.0 | 11.5 | – | 27 | 62.0 |
| 306/307/502/503/ 656/657 | 065.611 | ● | ● | 3/4 | 3/4 | 35.0 | 14.0 | 14.0 | 18.0 | – | 32 | 90.0 |

¹ Not to be used with non-return valve or strainer.

² Replace "xx" with the desired material no.

Ordering Type + Material no. = Ordering no.
example: 065.217.17.yy + 17 = 065.217.17.yy.17

Ball joints with threaded connection



Ball joints with female thread

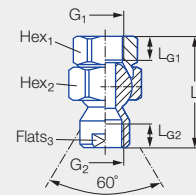

| For all nozzles with | Ordering no. | | | | G ₁ BSPP | G ₂ BSPP | Dimensions [mm] | | | | | | Weight [g] (Brass) |
|----------------------|--------------|---------------------------|-------------|------|------------------------|------------------------|-----------------|-----------------|-----------------|------------------|------------------|-------|--------------------|
| | Type | Mat. no. | | Code | | | L | L _{G1} | L _{G2} | Hex ₁ | Hex ₂ | Flats | |
| | | 16 Stainless steel 303 | 30 Brass | | | | | | | | | | |
| 1/8" male thread | 092.010 | ● | ● | AB | 1/8 | 1/8 | 43.1 | 8.0 | 8.0 | 22 | 24 | 13 | 110.0 |
| 1/4" male thread | 092.020 | ● | ● | AD | 1/4 | 1/4 | 60.3 | 12.0 | 11.5 | 27 | 27 | 17 | 200.0 |
| | 092.021 | ● | ● | AF | 3/8 | 1/4 | 58.3 | 12.0 | 11.5 | 27 | 27 | 17 | 160.0 |
| 3/8" male thread | 092.030 | ● | ● | AF | 3/8 | 3/8 | 56.0 | 12.0 | 12.0 | 27 | 30 | 19 | 185.0 |
| 1/2" male thread | 092.040 | ● | ● | AH | 1/2 | 1/2 | 71.0 | 15.5 | 15.5 | 36 | 41 | 24 | 425.0 |
| 3/4" male thread | 092.050 | ● | ● | AL | 3/4 | 3/4 | 80.0 | 17.0 | 17.0 | 41 | 46 | 30 | 595.0 |

Ball joints with male thread

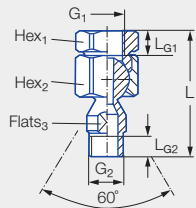

| Series | Ordering no. | | | | G ₁ BSPP | G ₂ BSPP | Dimensions [mm] | | | | | | Weight [g] (Brass) |
|---|--------------|---------------------------|-------------|------|------------------------|------------------------|-----------------|-----------------|-----------------|------------------|------------------|-------|--------------------|
| | Type | Mat. no. | | Code | | | L | L _{G1} | L _{G2} | Hex ₁ | Hex ₂ | Flats | |
| | | 16 Stainless steel 303 | 30 Brass | | | | | | | | | | |
| 226/216/2TR/ 302/308/350/ 468/652/684/ 548/679 | 092.022 | ● | ● | AD | 1/4 | 3/8 | 64.0 | 12.0 | 10.0 | 27 | 27 | 17 | 135.0 |
| | 092.022 | ● | ● | AF | 3/8 | 3/8 | 62.0 | 12.0 | 10.0 | 27 | 27 | 17 | 165.0 |

Compact ball joints

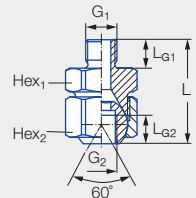

| For all nozzles with | Ordering no. | | | | G ₁ BSPP | G ₂ BSPP | Dimensions [mm] | | | | | Weight [g] (Brass) |
|----------------------|--------------|---------------------------|-------------|------|------------------------|------------------------|-----------------|-----------------|-----------------|------------------|------------------|--------------------|
| | Type | Mat. no. | | Code | | | L | L _{G1} | L _{G2} | Hex ₁ | Hex ₂ | |
| | | 16 Stainless steel 303 | 30 Brass | | | | | | | | | |
| 1/8" male thread | 092.010 | ● | ● | AA | 1/8 | 1/8 | 29.3 | 8.0 | 8.0 | 22 | 24 | 70.0 |
| 1/4" male thread | 092.024 | ● | ● | AC | 1/4 | 1/4 | 44.0 | 12.0 | 12.0 | 27 | 27 | 140.0 |
| 3/8" male thread | 092.030 | ● | ● | AE | 3/8 | 3/8 | 44.0 | 12.0 | 12.0 | 27 | 30 | 160.0 |

Ordering Type + Material no. + Code = Ordering no.
 example: 092.010 + 16 + AB = 092.010.16.AB

Ball joints with welding connection and female thread



Ball joints with welding connection and female thread

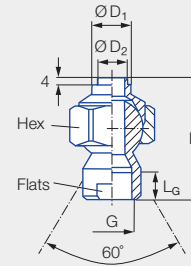

| For all nozzles with | Ordering no. | | | | G BSPP | Dimensions [mm] | | | | | | Weight [g] (Brass) |
|----------------------|--------------|----------|----|------|--------|-----------------|----------------|------------------|------------------|-----|-------|--------------------|
| | Type | Mat. no. | | Code | | L | L _G | Ø D ₁ | Ø D ₂ | Hex | Flats | |
| | | 16 | 30 | | | | | | | | | |
| 1/8" male thread | 092.010 | ● | ● | SB | 1/8 | 43.0 | 8.0 | 18.0 | 12.0 | 24 | 13 | 70.0 |
| 1/4" male thread | 092.020 | ● | ● | SD | 1/4 | 64.5 | 11.5 | 20.0 | 15.0 | 27 | 17 | 150.0 |
| 3/8" male thread | 092.030 | ● | ● | SF | 3/8 | 59.0 | 12.0 | 22.0 | 15.0 | 30 | 19 | 165.0 |
| 1/2" male thread | 092.040 | ● | ● | SH | 1/2 | 71.1 | 15.5 | 22.0 | 15.0 | 41 | 24 | 350.0 |
| 3/4" male thread | 092.050 | ● | ● | SL | 3/4 | 74.8 | 17.0 | 22.0 | 18.0 | 46 | 30 | 470.0 |

Ball joints with welding connection and male thread

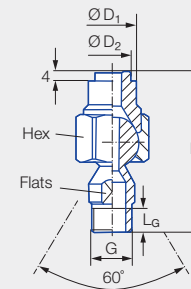
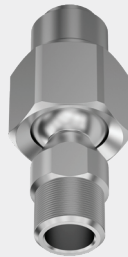

| Series | Ordering no. | | | | G BSPP | Dimensions [mm] | | | | | | Weight [g] |
|---|--------------|----------|----|------|--------|-----------------|----------------|------------------|------------------|-----|-------|------------|
| | Type | Mat. no. | | Code | | L | L _G | Ø D ₁ | Ø D ₂ | Hex | Flats | |
| | | 16 | 30 | | | | | | | | | |
| 226/216/2TR/ 302/308/350/ 468/652/684/ 548/679 | 092.022 | ● | | SE | 3/8 A | 68.0 | 10.0 | 20.0 | 15.0 | 27 | 17 | 155.0 |

Ordering Type + Material no. + Code = Ordering no.
example: 092.010 + 16 + SB = 092.010.16.SB

Accessories for nozzle series 676 with integrated ball joint



Threaded sockets

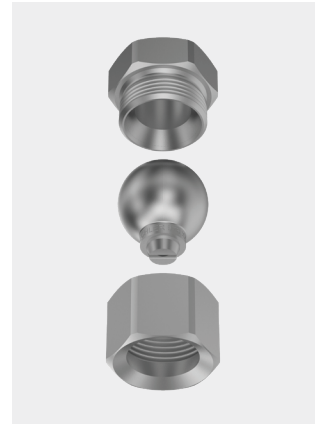
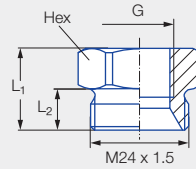

| Series | Ordering no. | | G BSPP | Dimensions [mm] | | | Weight [g] (Brass) | |
|--------|-------------------------------|---------------------|-----------|--------------------|----------------|------|--------------------------|------|
| | Type | Mat. no. | | L ₁ | L ₂ | Hex | | |
| | | 16 | | | | | | 30 |
| | | Stainless steel 303 | Brass | | | | | |
| 676 | 092.020.xx.AF.03 ¹ | ● | ● | 3/8 | 20.0 | 10.0 | 27 | 50.0 |

¹ Replace "xx" by material no.

Threaded nipple

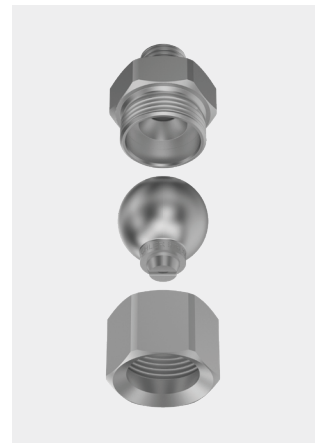
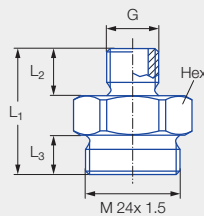

| Series | Ordering no. | | G BSPP | Dimensions [mm] | | | Weight [g] (Brass) | | |
|--------|-------------------------------|---------------------|-----------|--------------------|----------------|----------------|--------------------------|----|------|
| | Type | Mat. no. | | L ₁ | L ₂ | L ₃ | | | |
| | | 16 | | | | | | 30 | |
| | | Stainless steel 303 | Brass | | | | | | |
| 676 | 092.024.xx.AC.03 ¹ | ● | ● | 1/4 | 32.0 | 12.0 | 10.0 | 27 | 70.0 |

¹ Replace "xx" by material no.

Order Type + Material no. = Ordering no.
example: 092.020.xx.AF.03 + 16 = 092.020.16.AF.03

Welded nipple

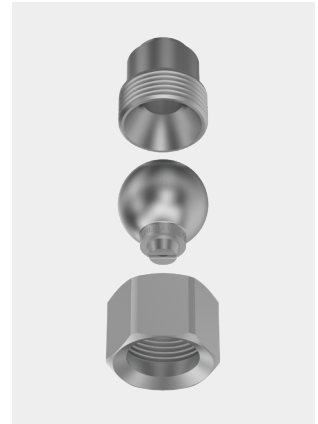
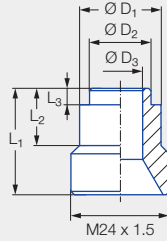

| Series | Ordering no. | | Dimensions [mm] | | | | | | Weight [g] |
|--------|------------------|-----------------------|-----------------|----------------|----------------|------------------|------------------|------------------|------------|
| | Type | Mat. no. | L ₁ | L ₂ | L ₃ | Ø D ₁ | Ø D ₂ | Ø D ₃ | |
| | | 17 | | | | | | | |
| | | Stainless steel 316Ti | | | | | | | |
| 676 | 092.020.17.00.04 | ● | 26.0 | 14.0 | 4.0 | 20.0 | 15.0 | 11.0 | 45.0 |

Retaining nuts

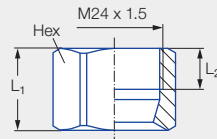
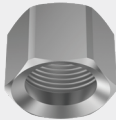

| Series | Ordering no. | | Dimensions [mm] | | | | Weight [g] (Brass) |
|--------|-------------------------------|---------------------|-----------------|----------------|----------------|-----|--------------------|
| | Type | Mat. no. | | L ₁ | L ₂ | Hex | |
| | | 16 | 30 | | | | |
| | | Stainless steel 303 | Brass | | | | |
| 676 | 092.020.xx.00.02 ¹ | ● | ● | 20.0 | 10.0 | 27 | 35.0 |

¹ Replace "xx" by material no.

Notice: The assembly accessories shown can be used with the low pressure flat fan nozzle with ball joint (series 676) (see Page 140/248).

Order Type + Material no. = Ordering no.
 example: 092.020.xx.00.02 + 16 = 092.020.16.00.02



Filter

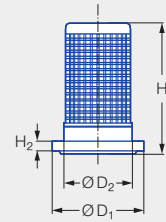

| Series | Nozzle size | Ordering no. | | Colour | Dimensions [mm] | | | | | Weight [g] |
|---|-----------------|----------------|----------------|--------|-----------------|----------------|----------------|------------------|------------------|------------|
| | | Type | Mat. no. | | Mesh size | H ₁ | H ₂ | Ø D ₁ | Ø D ₂ | |
| 216/2TR/ 302/468/ 422 bayonet/ 652/646/684 | xxx.32x-xxx.44x | 065.257 | ● 56 POM | Blue | 0.25 | 21.40 | 2.00 | 14.80 | 11.00 | 2.00 |
| | xxx.48x-xxx.56x | 065.256 | ● | Red | 0.65 | 21.40 | 2.00 | 14.80 | 11.00 | 2.00 |

Filter

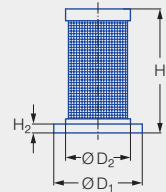

| Series | Nozzle size | Ordering no. | | Colour | Dimensions [mm] | | | | | Weight [g] |
|---|-----------------|---------------------------|--------------------------|------------|-----------------|----------------|----------------|------------------|------------------|------------|
| | | Type | Mat. no. | | Mesh size | H ₁ | H ₂ | Ø D ₁ | Ø D ₂ | |
| 216/2TR/ 302/468/ 422 bayonet/ 652/646/684 | xxx.32x-xxx.44x | 095.016.53.15.62 | ● 53 Polypropylene | Light pink | 0.08 | 21.00 | 1.60 | 15.00 | 11.00 | 1.00 |
| | | Strainer insert 304 SS | | | | | | | | |

Cup strainer

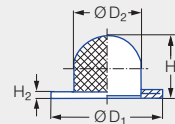

| Series | Nozzle size | Ordering no. | | Mesh size | Dimensions [mm] | | | | Weight [g] |
|---|-----------------|----------------|-------------------------|-----------|-----------------|----------------|------------------|------------------|------------|
| | | Type | Mat. no. | | H ₁ | H ₂ | Ø D ₁ | Ø D ₂ | |
| 216/2TR/ 302/468/ 422 bayonet/ 652/646/684 | xxx.32x-xxx.44x | 065.252 | ● 26 Monel/Copper | 0.5 | 8.5 | 1.6 | 14.8 | 9.0 | 1.0 |

Ordering Type + Material no. = Ordering no.
example: 065.257 + 56 = 065.257.56

Filters with ball-type non-return valve



Ball-type non-return valve
with integrated filter
 $P_{max} = 20 \text{ bar}$

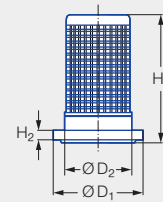

| Series | Nozzle size | Ordering no. | | Colour | Pressure [bar] | | Dimensions [mm] | | | | | Weight [g] |
|---|-----------------|----------------|----------|--------|------------------|------------------|-----------------|----------------|----------------|------------------|------------------|------------|
| | | Type | Mat. no. | | Opening pressure | Closing pressure | Mesh size | H ₁ | H ₂ | Ø D ₁ | Ø D ₂ | |
| | | | 56 | | | | | | | | | |
| 216/2TR/ 302/468/ 422 bayonet/ 652/646/684 | xxx.32x-xxx.44x | 065.265 | ● | Blue | 0.50-1.00 | 0.40-0.90 | 0.25 | 21.40 | 2.00 | 14.80 | 11.00 | 2.00 |
| | xxx.48x-xxx.56x | 065.266 | ● | Red | 0.40-0.50 | 0.35-0.45 | 0.65 | 21.40 | 2.00 | 14.80 | 11.00 | 2.00 |

Ball-type non-return valve
with integrated filter

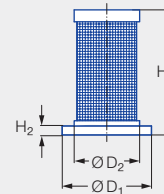

| Series | Nozzle size | Ordering no. | | Colour | Pressure [bar] | | Dimensions [mm] | | | | | Weight [g] |
|---|-----------------|-------------------------|----------|--------|------------------|------------------|-----------------|----------------|----------------|------------------|------------------|------------|
| | | Type | Mat. no. | | Opening pressure | Closing pressure | Mesh size | H ₁ | H ₂ | Ø D ₁ | Ø D ₂ | |
| | | | 53 | | | | | | | | | |
| 216/2TR/ 302/468/ 422 bayonet/ 652/646/684 | xxx.14x-xxx.36x | 095.016.53.11.00 | ● | Blue | approx. 0.50 | approx. 0.30 | 0.08 | 21.00 | 1.60 | 15.00 | 11.00 | 2.00 |
| | xxx.14x-xxx.36x | 095.016.53.14.63 | ● | Green | approx. 2.80 | approx. 1.60 | 0.08 | 21.00 | 1.50 | 15.00 | 11.00 | 2.00 |

Ordering Type + Material no. = Ordering no.
example: 065.265 + 56 = 065.265.56

Retaining nuts and gaskets



Retaining nuts

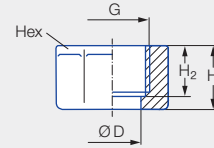
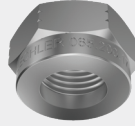

| Series | Ordering no. | | | | | | G BSPP | Dimensions [mm] | | | | Weight [g] (Brass) | |
|---|--------------|---------------------|-----------------------|----------------------|-------|-------------|-----------|-----------------|----------------|------|------|-----------------------|------------|
| | Type | Mat. no. | | | | | | H ₁ | H ₂ | Ø D | Hex | | |
| | | 16 | 17 ¹ | 1Y | 30 | 56 Black | | | | | | | 5E Blue |
| | | Stainless steel 303 | Stainless steel 316Ti | Stainless steel 316L | Brass | POM | PVDF | | | | | | |
| 226/2TR/ 468/652/660/ 684/548/679 | 065.200 | ● | ● | | ● | | | 3/8 | 13.0 | 10.0 | 12.8 | 22 | 25.0 |
| | 065.200 | | | | | ● | ● | 3/8 | 14.5 | 11.5 | 13.0 | 22 | 25.0 |
| | 069.000 | ● | | ● | ● | | | UNF 11/16 | 14.3 | 9.7 | 13.1 | 20.6 | 25.0 |
| 656/657/ 664/665 | 065.600 | ● | ● | | ● | | ● | 3/4 | 16.0 | 13.0 | 20.1 | 32 | 60.0 |

¹ We reserve the right to supply material 316Ti or 316L under material no. 17.

Gaskets

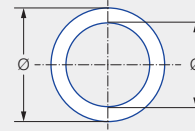

| Series | Nozzle Code | Ordering no. | | | | Dimensions [mm] | Weight [g] | |
|---|-------------------|--------------------|------------------|-------------------------|-------------|--------------------------|------------|----|
| | | Type | Mat. no. | | | | | |
| | | | 55 | 71 | 72 | | | 73 |
| | | PTFE | Cu. ISO PL. 7504 | EWP 210 (asbestos-free) | Soft rubber | | | |
| 610 | 1/8 BSPP | 061.040 | | ● | | Ø 10.00 x Ø 14.00 x 1.00 | 0.13 | |
| 220/612 | 1/4 BSPP | 061.240 | ● | ● ¹ | ● | Ø 13.20 x Ø 17.00 x 1.00 | 0.20 | |
| 490/491/ 460/461/ 616/617/689 | 3/4 BSPP | 061.640 | | ● ² | ● | Ø 26.50 x Ø 32.00 x 1.00 | 0.50 | |
| 405 | 1 1/4 BSPP | 062.140 | | | ● | Ø 42.00 x Ø 50.00 x 1.00 | 1.20 | |
| 405 | 2 BSPP | 062.540 | | | ● | Ø 60.00 x Ø 70.00 x 2.00 | 3.92 | |
| 226/468/652/ 684/679 | Retaining nut 3/8 | 065.240 | ● | | ● | Ø 11.00 x Ø 15.00 x 1.00 | 0.14 | |
| 656/657 | Retaining nut 3/4 | 065.640 | | | ● | Ø 18.00 x Ø 24.00 x 1.00 | 0.50 | |
| PTFE sealing tape For connecting cylindrical female threads and tapered male threads BSPT | | 095.009.55.09.30.0 | | | | 12 mm x 0.1 mm x 12 m | - | |

¹ Dimensions [mm] for mat. no. 71: 13.20 x 17.00 x 2.00.

² Dimensions [mm] for mat. no. 71: 26.50 x 32.00 x 2.50.

Ordering Type + Material no. = Ordering no.
 example: 065.200 + 16 = 065.200.16

Strainers

Max. 12 bar



Standard strainer for industrial application

- For operating pressure levels up to 12 bar.
With large filter surfaces
- Mesh size is colour coded:
 - 0.6 mm = red
 - 0.3 mm = blue
 - 0.2 mm = green
- Easy handling
- Robust version
- Slender design

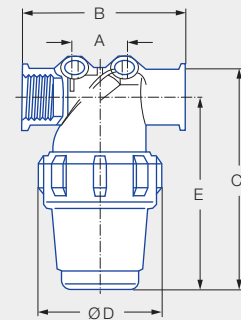

| Type | | Code BSPP | Dimensions [mm] | | | | | Weight [g] |
|---------------|---------------|-----------|-----------------|-------|-------|-------|-------|------------|
| | | | A | B | C | S | ØD | |
| S.GA2. | S.GI2. | 1/2 | 27.0 | 97.0 | 140.0 | 118.0 | 74.0 | 200.0 |
| S.GA3. | S.GI3. | 3/4 | 27.0 | 97.0 | 140.0 | 118.0 | 74.0 | 200.0 |
| S.GA4. | S.GI4. | 1 | 40.0 | 112.0 | 175.0 | 143.0 | 86.0 | 300.0 |
| S.GA5. | S.GI5. | 1 1/4 | 39.0 | 146.0 | 280.0 | 239.0 | 116.0 | 630.0 |
| S.GA6. | S.GI6. | 1 1/2 | 39.0 | 146.0 | 280.0 | 239.0 | 116.0 | 630.0 |

Pressure/Temperature ranges

| Max. temperature [°C] | p _{max} [bar] |
|-----------------------|------------------------|
| 20 | 12 |
| 60 | 7 |

| | Ordering no. | | | Standard strainer insert/Standard filter | |
|---------------|---------------|-------------|---------------------|--|--------------------|
| | Type | Size | Mat. no. | Mesh size [mm] | Type (blue) |
| | | | 53 Polypropylene | | |
| Male thread | S.GA2. | 012. | ● | 0.3 | S.000.012.00.26.03 |
| | S.GA3. | 034. | ● | 0.3 | S.000.012.00.26.03 |
| | S.GA4. | 100. | ● | 0.3 | S.000.100.00.26.03 |
| | S.GA5. | 114. | ● | 0.3 | S.000.114.00.26.03 |
| | S.GA6. | 112. | ● | 0.3 | S.000.114.00.26.03 |
| Female thread | S.GI2. | 012. | ● | 0.3 | S.000.012.00.26.03 |
| | S.GI3. | 034. | ● | 0.3 | S.000.012.00.26.03 |
| | S.GI4. | 100. | ● | 0.3 | S.000.100.00.26.03 |
| | S.GI5. | 114. | ● | 0.3 | S.000.114.00.26.03 |
| | S.GI6. | 112. | ● | 0.3 | S.000.114.00.26.03 |

| Optional strainer inserts | | | |
|---------------------------|--------------------|----------------|--------------------|
| Mesh size [mm] | Type (red) | Mesh size [mm] | Type (green) |
| 0.6 | S.000.012.00.26.06 | 0.2 | S.000.012.00.26.02 |
| 0.6 | S.000.012.00.26.06 | 0.2 | S.000.012.00.26.02 |
| 0.6 | S.000.100.00.26.06 | 0.2 | S.000.100.00.26.02 |
| 0.6 | S.000.100.00.26.06 | 0.2 | S.000.100.00.26.02 |
| 0.6 | S.000.114.00.26.06 | 0.2 | S.000.114.00.26.02 |
| 0.6 | S.000.114.00.26.06 | 0.2 | S.000.114.00.26.02 |
| 0.6 | S.000.012.00.26.06 | 0.2 | S.000.012.00.26.02 |
| 0.6 | S.000.012.00.26.06 | 0.2 | S.000.012.00.26.02 |
| 0.6 | S.000.012.00.26.06 | 0.2 | S.000.012.00.26.02 |
| 0.6 | S.000.100.00.26.06 | 0.2 | S.000.100.00.26.02 |
| 0.6 | S.000.100.00.26.06 | 0.2 | S.000.100.00.26.02 |
| 0.6 | S.000.114.00.26.06 | 0.2 | S.000.114.00.26.02 |
| 0.6 | S.000.114.00.26.06 | 0.2 | S.000.114.00.26.02 |

Notice: Standard strainer insert (blue) included in the scope of supply.

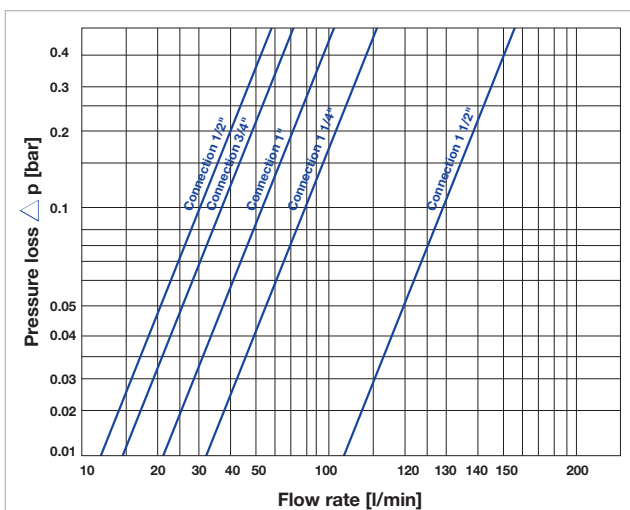

Correction factors for Δp

| Viscosity [mPa·s] | Basket – mesh size [mm] | | |
|-------------------|-------------------------|-----|-----|
| | 0.6 | 0.3 | 0.2 |
| 1.0 (water) | 1.0 | 1.2 | 1.4 |
| 100.0 | 1.6 | 1.9 | 2.0 |
| 200.0 | 1.7 | 2.2 | 2.3 |

Ordering Type + Size + Material no. = Ordering no.
example: S.GA2. + 012. + 53 = S.GA2.012.53

Strainers

Max. 8 bar



Strainer with high flow rate and low resistance

- Integrated flow deflector prevents clogging of the filter insert
- Dirt particles can be removed via an offset outlet port
- Prepared for the install of two pressure gauges

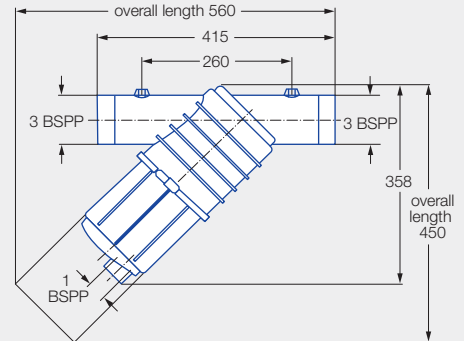

Strainer with screen

| Type | Size | Ordering no. | | Screen mesh size [µm/mesh] |
|--------|------|---------------|--|----------------------------|
| | | Mat. no. | | |
| | | 53 | | |
| | | Polypropylene | | |
| S.GA2. | 300. | ● | | 594/32 |
| S.GA3. | 300. | ● | | 365/50 |
| S.GA4. | 300. | ● | | 173/100 |
| S.GA5. | 300. | ● | | 144/120 |

Screen

| Type | Size | Ordering no. | | Screen mesh size [µm/mesh] |
|--------|---------|---------------------|----------------------------|----------------------------|
| | | Mat. no. | | |
| | | 26 | 5A | |
| | | Stainless steel 304 | Polyester/ Stainless steel | |
| S.002. | 300.00. | ● | | 594/32 |
| S.003. | 300.00. | ● | | 365/50 |
| S.004. | 300.00. | ● | | 173/100 |
| S.005. | 300.00. | | ● | 144/120 |

Pressure loss chart

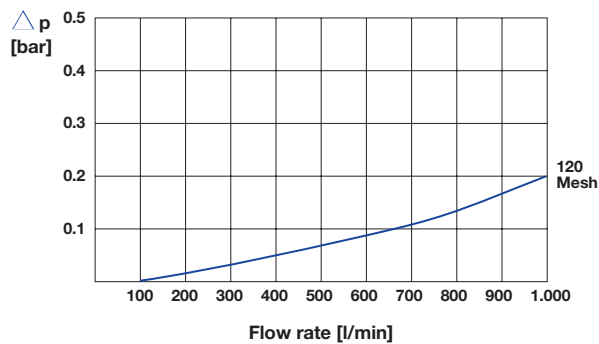

Technical data

| | |
|-----------------------------|---------------------|
| Screening surface | 860 cm ² |
| Screening insert Ø | 145 mm |
| Height of screening insert | 320 mm |
| Inflow/Outflow port Ø | 3" |
| Pressure gauge connection Ø | 1/4 BSPP |
| Max. operating pressure | 8 bar |

Ordering example for strainer:

Ordering Type + Size + Material no. = Ordering no.
 example: S.GA2. + 300. + 53 = S.GA2.300.53

Ordering example for strainer insert:

Ordering Type + Size + Material no. = Ordering no.
 example: S.002. + 300.00. + 26 = S.002.300.00.26

